

MOVING YOU FURTHER

# HW180

With Tier 4 final / Stage IV Engine installed



\*Photo may include optional equipment.

**Net Power**

SAE J1349 / 127 kW (171 HP) at 1,800 rpm

**Gross Power**

SAE J1995 / 134 kW (180 HP) at 1,800 rpm

**Travel Speed**

35 km/h (21.7 mph)

**Operating Weight**

17,800 kg (39,240 lb)







# RULE THE GROUND

The HW Series excavators are products of HHI's spirit of initiative, creativity and strong drive. HHI's engineers, who are the best in the industry, have worked tirelessly to offer a zero-defect product. The new HW Series reflects customers' needs in the field gleaned by thorough monitoring. They maximize fuel efficiency and performance proven by rigorous field tests and quality control.







\*Photo may include optional equipment.

# RULE THE GROUND

The HW series exceeds customers' expectation!  
Become a true leader on the ground with HHI's HW series.



## WORK MAX, WORTH MAX

- ECO Gauge
- IPC (Intelligent Power Control)
- New Variable Power Control
- Electronic Viscous Fan Clutch
- Attachment Flow Control (Option)
- New Cooling System with Increased Air Flow
- Enlarged Air Inlet with Grill Cover
- Cycle Time Improvement



## MORE RELIABLE, MORE SUSTAINABLE

- Durable Cooling Module
- Reinforced Pin, Bush and Polymer Shim
- Reinforced Durability of Upper and Lower Structure and Attachments
- Wear Resistant Cover Plate
- Hi-grade (High-pressure) Hoses



## INFOTAINMENT FRONTIER

- Intelligent and Wide Cluster
- Haptic Control
- Operating Simulation for Joy & Achievement
- Wi-Fi Direct with Smart Phone (Miracast)
- Proportional Auxiliary Hydraulic System
- New Audio System
- New Air Conditioning System





# HW180



## MODERN COMFORT, SIMPLE AND SAFE SOLUTION

- AAVM (Advanced Around View Monitoring) Camera System (Option)
- Easy Access to DEF/AdBlue® Supply System
- Hi-mate (Remote Management System) (Option)
- Swing Lock System (Option)
- Fine Swing Control (Option)



\*Photo may include optional equipment.

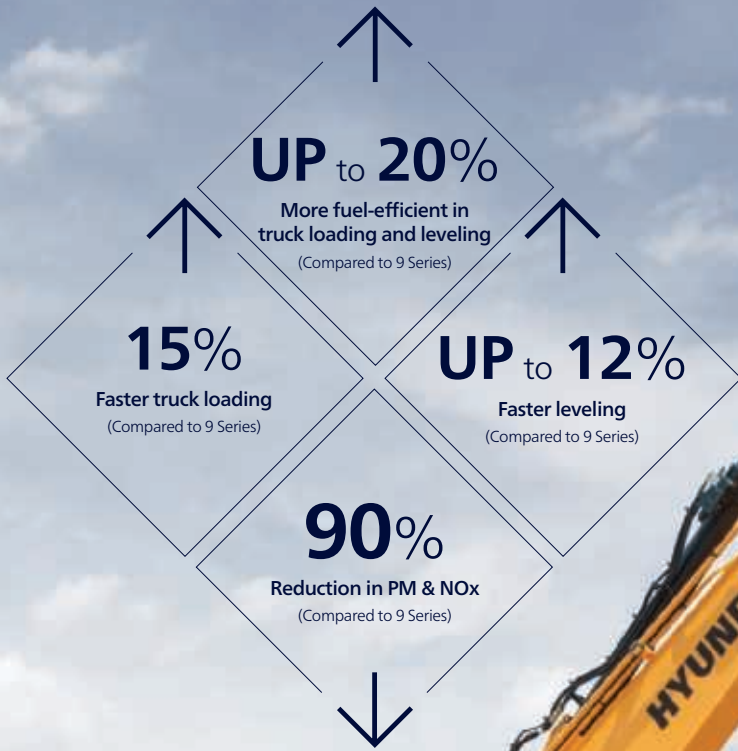

\*Photo may include optional equipment.

**Fuel Rate Information**



**Cycle Time Improvement**

The HW Series provides higher productivity on the site by faster operation: it loads trucks up to 15% faster and levels up to 12% faster than the 9 Series.



# WORK MAX, WORTH MAX

## Fuel Efficient System, Allows Great Performance

The HW Series has an eco-friendly, high-performance engine which ensures both excellent fuel efficiency and high power. With outstanding operating performance proven by rigorous tests at various work sites, it will satisfy any customer's needs.



### ECO Colored Gauge

ECO Gauge enable economic operation of machines. The gauge level and color displays engine torque and fuel efficiency level. On top of that, the status of fuel consumption such as average rate and the total amount of fuel consumed are displayed. Hourly and daily based fuel consumption can be checked in the detailed menu as well.



### IPC (Intelligent Power Control)

The IPC controls power control depending on work environments. Its mode can be selected and released on the monitor. On the excavation mode, pump flow can be easily controlled by a lever, reducing fuel consumption.

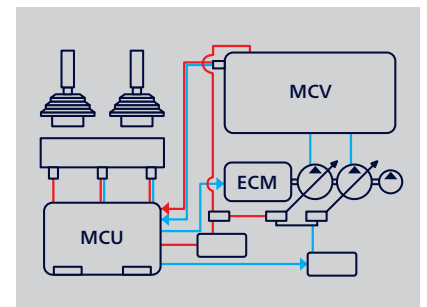

### New Variable Power Control

The HW Series minimizes equipment input and output control signals to improve fuel efficiency. Its three-stage Power mode ensures the highest performance in any operating environment.

- \* P (power) mode: Maximizes speed and power of the equipment for heavy load work.
- \* S (standard) mode: Optimizes performance and fuel efficiency of the equipment for general load work.
- \* E (economy) mode: Improves the control system for light load work.



### Attachment Flow Control (Option)

The HW Series improves pump flow rate by independent control of two pumps. It optimizes attachments for effective flow rate setting depending on attachments (ten breaker types and ten crusher types), enabling various operations matching the site environments.



### New Cooling System with Increased Air Flow

The HW Series provides excellent cooling performance by increasing heat dissipation and can be easily cleaned.

### Electronic Viscous Fan Clutch

The electronic fan clutch reduces noise during operation by precisely controlling RPM depending on the hydraulic oil and coolant temperature of the working vehicle, and minimizes fuel consumption. It is also possible to shorten the warm up time of hydraulic oil.

### Enlarged Air Inlet with Grill Cover

Enlarged vent hole of the air inlet side cover and fine net grill to prevent penetration of foreign materials further improve durability.

# MORE RELIABLE, MORE SUSTAINABLE

## New Exterior Design for Robustness and Safety

The true value of the HW Series lies in its durability. The robust upper and lower frame structure that can endure external shock and high-load work and the attachments whose performance was proven by rigorous tests further show the real value of the HW Series in tough working environments and promise higher productivity.

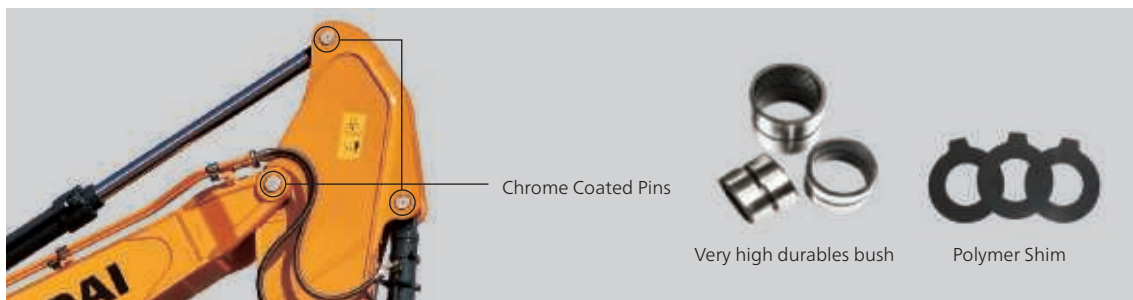

## Reinforced Pin, Bush and Polymer Shim

The HW series improves lubricity of connecting parts between the equipment and attachments. Gaps with attachments are minimized by wear-resistant long-life pins, bushes and polymer shims, supporting the highest performance with invariable durability.



## Durable Cooling Module

The HW series has a durable cooling module that passed stringent tests, demonstrating the highest productivity in tough working environments.



## Reinforced Durability of Upper and Lower Structure and Attachments

The upper and lower structure and attachments of the HW Series have higher durability than demanded on the site, as proven through numerous tests including road tests and virtual simulation. The wear resistance of the bucket has been improved by use of new material.





\*Photo may include optional equipment



### Hi-grade (High-pressure) Hoses

The HW Series uses high-pressure hoses with improved heat and pressure resistance, greatly increasing the durability of the equipment.





\*Photo may include optional equipment.

### **New Air Conditioning System**

With further improved air conditioning and heating, the HW Series increases the APTC capacity by 15% to provide a pleasant environment for operators all the time. The ventilation was designed such that warm and cool air even reach operators' faces (increasing their work satisfaction) or allowing pleasant working environment.



# INFOTAINMENT FRONTIER

## Enhanced Instrument Panel for Easier Monitoring

Many electronic functions are concentrated on the most convenient spot for operators to ensure work efficiency. The highly-advanced infotainment system, a product of HHI's intensive information technology, enables both productivity and pleasant work at the same time! The HW Series of HHI provides higher value and pleasure to customers.



### Intelligent and Wide Cluster

The 8-inch capacitive-type display (like smartphone display) of the HW Series is 30% larger than the previous model, delivering excellent legibility. The centralized switches on the display allow convenience of checking the urea level and temperature outside the cabin. The audio AUX, air conditioner, heater interoperation, wiper, lamps, overload warnings, travel alarm and inclination sensor also maximize operator's convenience.



### Haptic Control

The integrated jog shuttle-type haptic controller applies to the accelerator, remote air conditioner controller and operation of the cluster, allowing convenient operation. In the event of failure of the haptic switch, the emergency mode is activated on the cluster to ensure fail-safe function.



### New Audio System

Radio player, USB-based MP3 player, integrated Bluetooth hands-free feature, and built-in microphone allow convenient phone calls while in work and in transit. The radio player was moved to the right side from the rear, allowing easier access.

### Wi-Fi Direct with Smart Phone (Miracast)

The Miracast system based on Wi-Fi of the operator's smart phone enables easy and convenient use of various features of the smart phone on the big screen including navigation, web surfing, viewing of videos, and listening to music. (For Android mobile phone now)



### Proportional Auxiliary Hydraulic System

- Opt: Proportional control switch for better speed control
- Enlarge the operation convenience

# MODERN COMFORT, SIMPLE AND SAFE SOLUTION

## New Cabin for More Comfort

Low noise, low vibration, and ergonomic design make the cabin space more comfortable and pleasant! With focus on safety and convenience of operators, the HW Series allows rapid and safe equipment inspection anytime and anywhere, providing an optimal environment for operators to work.



### AAVM (Advanced Around View Monitoring) Camera System (Option)

The HW Series has a state-of-the-art AAVM video camera system to secure field of vision for operators in all directions, thereby preventing accidents. Operators can easily check the workplace in the front, rear and to the right and left.



- \* AAVM (Advanced Around View Monitoring): Secure field of vision in all directions by nine views including 3D bird's eye view and 2D/4CH view.
- \* IMOD (Intelligent Moving Object Detection): Inform when people or dangerous objects are detected within the range of operation (recognition distance: 5 m).



### Easy Access to DEF/AdBlue® Supply System

The DEF/AdBlue® tank is installed inside the tool box and its inlet is remotely located for easy access and convenient supply. Warning of overfill is given by a red lamp signal.



### Hi-mate (Remote Management System) (Option)

Hi-mate, Hyundai's proprietary remote management system, provides operators and dealer service personnel access to vital service and diagnostic information on the machine from any computer with internet access. Users can pinpoint machine location using digital mapping and set machine work boundaries, reducing the need for multiple service calls. Hi-mate saves time and money for the owner and dealer by promoting preventative maintenance and reducing machine downtime.

- \* Operation of the system may be affected by the condition of telecommunication signal





\*Photo may include optional equipment.

### **Swing Lock System (Option)**

Swing Lock System is provided to maintain stability when swing movement needs to be limited, improving operating speed and productivity.

### **Fine Swing Control (Option)**

Fine swing control is available for customer's convenience when users want to control fine swing.

# SPECIFICATIONS

ENGINE			
Maker / Model		Cummins QSB6.7	
Type		Water-cooled, 4-cycle diesel, 6-cylinder in-line, Direct injection, Turbocharged, Charge air cooled, Low emission	
Rated flywheel horse power	SAE	J1995 (gross)	134 kW (180 HP) at 1,800 rpm
		J1349 (net)	127 kW (171 HP) at 1,800 rpm
	DIN	6271/1 (gross)	134 kW (182 PS) at 1,800 rpm
		6271/1 (net)	127 kW (173 PS) at 1,800 rpm
Max. torque		85.7 kgf-m (620 lbf-ft) at 1,500 rpm	
Bore x stroke		107 x 124 mm (4.21" x 4.88")	
Piston displacement		6,700 cc (409 cu in)	
Batteries		2 x 12 V x 100 Ah	
Starting motor		24 V - 4.8 kW	
Alternator		24 V - 95 A	

HYDRAULIC SYSTEM	
MAIN PUMP	
Type	Two variable displacement piston pumps
Max. flow	2 x 172 l/min (45.4 US gpm/37.8 UK gpm)
Sub-pump for pilot circuit	Gear pump

Cross-sensing and fuel saving pump system

HYDRAULIC MOTORS	
Travel	Variable displacement axial piston motor with brake valve
Swing	Axial piston motor with automatic brake

RELIEF VALVE SETTING	
Implement circuits	350 kgf/cm <sup>2</sup> (4,970 psi)
Travel	380 kgf/cm <sup>2</sup> (5,400 psi)
Power boost (boom, arm, bucket)	380 kgf/cm <sup>2</sup> (5,400 psi)
Swing circuit	285 kgf/cm <sup>2</sup> (4,050 psi)
Pilot circuit	40 kgf/cm <sup>2</sup> (570 psi)
Service valve	Installed

HYDRAULIC CYLINDERS	
No. of cylinder bore x stroke	Boom: 2-115 x 1,090 mm (4.5" x 42.9")
	Arm: 1-120 x 1,355 mm (4.7" x 53.3")
	Bucket: 1-110 x 995 mm (4.3" x 39.2")
	Dozer Blade: 2-110 x 235 mm (4.3" x 9.3")
	Outrigger: 2-125 x 463 mm (4.9" x 18.2")
	2-Piece Boom: 2-115 x 960 mm (4.1" x 37.8")
Adjust (boom): 1-160 x 650 mm (6.29" x 25.6")	

DRIVES & BRAKES		
4-wheel hydrostatic drive. Constant mesh, helical gear transmission provides 2 forward and reverse travel speeds.		
Max. drawbar pull	10,320 kgf (22,750 lbf)	
Travel speed	1st	9.5 km/h
	2nd	35 km/h
Gradeability	35° (70 %)	

Parking brake : Independent dual brake, front and rear axle full hydraulic power brake.

- Spring released and hydraulic applied wet type multiple disk brake.
- Transmission is locked at neutral position for parking, automatically.

CONTROL	
Pilot pressure operated joysticks and pedals with detachable lever provide almost effortless and fatigueless operation.	

CONTROL	
Pilot control	Two joysticks with one safety lever (LH): Swing and arm (RH): Boom and bucket (ISO)
Engine throttle	Electric, Dial type
Lights	Two lights mounted on the boom, one under the battery box and one under the cabin

AXLE & WHEEL	
Full floating front axle is supported by center pin for oscillation. It can be locked by oscillation lock cylinders. Rear axle is fixed on the lower chassis.	
Tires	10.00-20-14PR, Dual (tube type)
(Optional)	10.00-20, Dual (solid type)

STEERING SYSTEM	
Hydraulically actuated, orbitrol type steering system actuates on front wheels through the steering cylinder.	
Min. turning radius	6,300 mm (20' 8")

SWING SYSTEM	
Swing motor	Fixed displacement axial piston motor
Swing reduction	Planetary gear reduction
Swing bearing lubrication	Grease-bathed
Swing brake (option)	Multi wet disc
Swing speed	9.3 rpm

SERVICE REFILL CAPACITIES			
		(:) : option	
Re-filling	liter	US gal	UK gal
Fuel tank	290	76.6	63.8
Engine coolant	19.5	5.2	4.3
Engine oil	23.7	6.3	5.2
Swing device - gear oil	6.2	1.64	1.36
Swing device - grease	(1.2)	(0.32)	(0.26)
Axle	Front	15.5	4.11
	Rear	17.5	4.6
Hydraulic system (including tank)	270	71.3	59.4
Hydraulic tank	125	32.8	27.3
DEF/AdBlue®	27	7.1	5.9

UNDERCARRIAGE	
Reinforced box-section frame is all-welded, low-stress. Dozer blade and outriggers are available. A pin-on design.	
Dozer blade	A very useful addition for leveling and back filling or clean-up work.
Outrigger	Indicated for max. operation stability when digging and lifting. Can be mounted on the front/or the rear.

OPERATING WEIGHT (APPROXIMATE)	
Operating weight, including 5,200 mm (17' 1") Mono boom; 2,600 mm (8' 6") arm; SAE heaped 0.76 m <sup>3</sup> (0.99 yd <sup>3</sup> ) backhoe bucket, lubricant, coolant, full fuel tank, full hydraulic tank and all standard equipments.	

OPERATING WEIGHT		
Undercarriage	Mono boom	Hyd. 2-Piece boom
Rear dozer blade	17,800 kg (39,240 lb)	18,270 kg (40,280 lb)
Rear outriggers	17,950 kg (39,570 lb)	18,420 kg (40,010 lb)
Front outriggers and rear blade	18,750 kg (41,340 lb)	19,220 kg (42,370 lb)
Front blade and rear outriggers	18,800 kg (41,450 lb)	19,270 kg (42,480 lb)
Four outriggers	18,900 kg (41,670 lb)	19,370 kg (42,700 lb)



# BUCKET SELECTION GUIDE & DIGGING FORCE

## BUCKETS

All buckets are welded with high-strength steel.



0.39 (0.51)



0.50 (0.65)



0.64 (0.84)  
0.70 (0.92)  
0.76 (0.99)



0.70 (0.92)



0.89 (1.16)  
1.05 (1.37)



■ 0.69 (0.90)



⊙ 0.75 (0.90)

SAE heaped  
m<sup>3</sup> (yd<sup>3</sup>)

Capacity m <sup>3</sup> (yd <sup>3</sup> )		Width mm (in)		Weight kg (lb)	Recommendation mm (ft.in)				
					5,200 (17' 1") Mono-boom			5,100 (16' 9") 2-Piece boom	
SAE heaped	CECE heaped	Without side cutters	With side cutters		2,200 (7' 3") Arm	2,600 (8' 6") Arm	3,100 (10' 2") Arm	2,200 (7' 3") Arm	2,600 (8' 6") Arm
0.39 (0.51)	0.34 (0.44)	650 (25.6)	740 (29.1)	410 (900)	●	●	●	●	●
0.50 (0.65)	0.44 (0.58)	790 (31.1)	880 (34.6)	470 (1,040)	●	●	●	●	●
0.64 (0.84)	0.55 (0.72)	950 (37.4)	1,040 (40.9)	510 (1,120)	■	■	▲	■	■
0.70 (0.92)	0.60 (0.78)	1,020 (40.2)	1,110 (43.7)	600 (1,320)	■	■	▲	■	▲
0.76 (0.99)	0.65 (0.85)	1,090 (42.9)	1,180 (46.5)	620 (1,370)	■	▲	▲	■	▲
0.89 (1.16)	0.77 (1.01)	1,250 (49.2)	1,340 (52.8)	610 (1,340)	▲	▲	-	▲	▲
1.05 (1.37)	0.90 (1.18)	1,430 (56.3)	1,520 (59.8)	680 (1,500)	▲	-	-	▲	-
■ 0.69 (0.90)	0.62 (0.81)	1,050 (41.3)	-	720 (1,590)	■	▲	▲	■	▲
⊙ 0.75 (0.98)	0.65 (0.85)	1,820 (71.7)	-	540 (1,190)	■	■	▲	■	▲

- Heavy duty bucket
- ⊙ Ditching bucket

- : Applicable for materials with density of 2,000 kg /m<sup>3</sup> (3,370 lb/ yd<sup>3</sup>) or less
- : Applicable for materials with density of 1,600 kg /m<sup>3</sup> (2,700 lb/ yd<sup>3</sup>) or less
- ▲ : Applicable for materials with density of 1,100 kg /m<sup>3</sup> (1,850 lb/ yd<sup>3</sup>) or less

## ATTACHMENT

Booms and arms are welded with a low-stress, full-box section design.

5.2 m (17' 1") Mono-boom and 5.1 m (16' 9") 2-Piece boom and 2.2 m (7' 3"); 2.6 m (8' 6") & 3.1 m (10' 2") Arms are available.

## DIGGING FORCE

Arm	Length	mm (ft.in)	2,200 (7' 3")	2,600 (8' 6")	3,100 (10' 2")	Remarks:
Bucket digging force	SAE	kN	107.9 [117.2]	107.9 [117.2]	107.9 [117.2]	[ ]: Power Boost
		kgf	11,000 [11,940]	11,000 [11,940]	11,000 [11,940]	
		lbf	24,250 [26,330]	24,250 [26,330]	24,250 [26,330]	
	ISO	kN	123.6 [134.2]	123.6 [134.2]	123.6 [134.2]	
		kgf	12,600 [13,680]	12,600 [13,680]	12,600 [13,680]	
		lbf	27,780 [30,160]	27,780 [30,160]	27,780 [30,160]	
Arm crowd force	SAE	kN	87.2 [94.7]	77.3 [83.9]	69.0 [74.9]	
		kgf	8,890 [9,650]	7,880 [8,560]	7,030 [7,630]	
		lbf	19,600 [21,280]	17,370 [18,860]	15,500 [16,830]	
	ISO	kN	91.0 [98.8]	80.3 [87.2]	71.4 [77.5]	
		kgf	9,280 [10,080]	8,190 [8,890]	7,280 [7,900]	
		lbf	20,460 [22,210]	18,060 [19,600]	16,050 [17,430]	

Note : Arm weight includes bucket cylinder, linkage and pin

# DIMENSIONS & WORKING RANGE

## HW180 MONO BOOM DIMENSIONS

5.2 m (17' 1") Mono-boom and 2.6 m (8' 6") Arm and rear dozer blade.

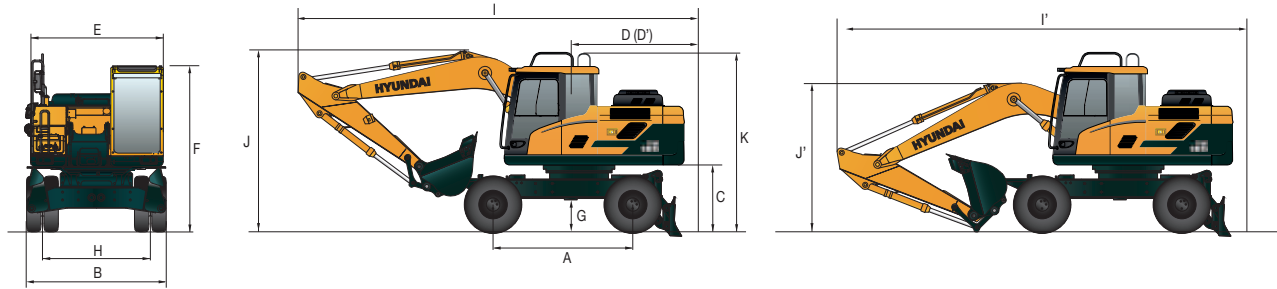

Unit : mm (ft-in)

A	Wheel base	2,600 (8' 6")
B	Overall width	2,500 (8' 2")
C	Ground clearance of counterweight	1,270 (4' 2")
D	Rear-end distance	2,430 (8' 0")
D'	Rear-end swing radius	2,430 (8' 0")
E	Upperstructure width	2,475 (8' 1")
F	Overall height of cab	3,190 (10' 6")
G	Min. ground clearance	340 (1' 1")
H	Tread	1,914 (6' 3")
K	Overall height of guardrail	3,420 (11' 3")

	Boom length	5,200 (16' 9")		
	Arm length	2,200 (7' 3")	2,600 (8' 2")	3,100 (10' 2")
I	Overall length (Traveling position)	8,590 (28' 7")	8,710 (28' 7")	8,480 (27' 10")
I'	Overall length (Shipping position)	8,650 (28' 5")	8,760 (28' 9")	8,760 (28' 9")
J	Overall height of boom (Traveling position)	3,610 (11' 10")	3,540 (11' 7")	3,900 (12' 10")
J'	Overall height of boom (Shipping position)	3,060 (10' 0")	3,180 (10' 5")	3,150 (10' 4")

## HW180 MONO BOOM WORKING RANGE

Unit : mm (ft-in)

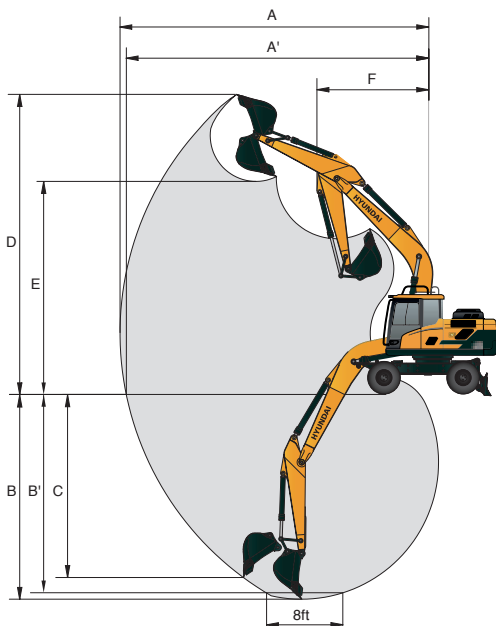

	Boom length	5,200 (17' 1")		
	Arm length	2,200 (7' 3")	2,600 (8' 6")	3,100 (10' 2")
A	Max. digging reach	8,820 (29' 1")	9,200 (30' 3")	9,450 (31' 1")
A'	Max. digging reach on ground	8,615 (28' 4")	9,000 (29' 7")	9,250 (30' 4")
B	Max. digging depth	5,500 (18' 2")	5,900 (19' 5")	6,320 (20' 9")
B'	Max. digging depth (8' level)	5,280 (17' 5")	5,700 (18' 9")	6,130 (20' 1")
C	Max. vertical wall digging depth	4,850 (16' 1")	5,310 (17' 6")	5,470 (17' 11")
D	Max. digging height	9,180 (30' 3")	9,300 (30' 7")	9,220 (30' 3")
E	Max. dumping height	6,520 (21' 5")	6,660 (21' 8")	6,620 (21' 9")
F	Min. front swing radius	3,290 (10' 9")	3,230 (10' 8")	3,160 (10' 4")



# DIMENSIONS & WORKING RANGE

## HW180 2-PIECE BOOM DIMENSIONS

5.1 m (16' 9") 2-Piece boom and 2.2 m (7' 3") Arm and rear dozer blade.

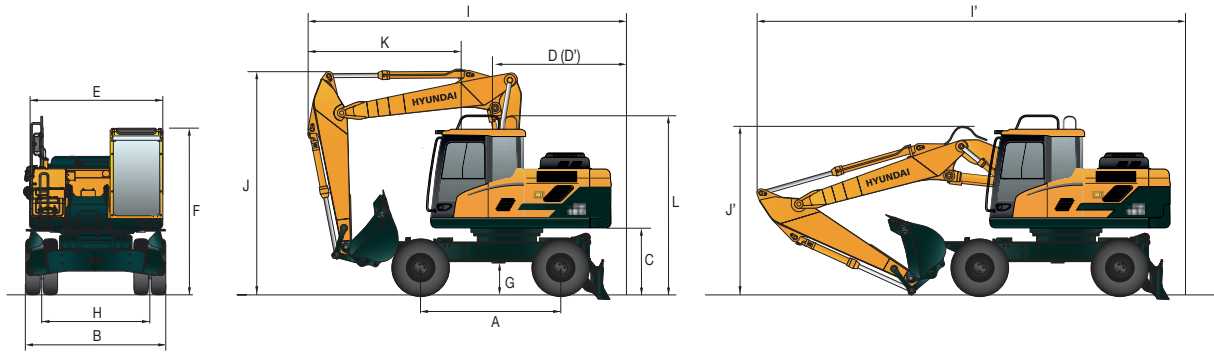

Unit : mm (ft-in)

A	Wheel base	2,600 (8' 6")
B	Overall width	2,500 (8' 2")
C	Ground clearance of counterweight	1,270 (4' 2")
D	Rear-end distance	2,430 (8' 0")
D'	Rear-end swing radius	2,430 (8' 0")
E	Upperstructure width	2,475 (8' 1")
F	Overall height of cab	3,190 (10' 6")
G	Min. ground clearance	340 (1' 1")
H	Tread	1,944 (6' 5")
L	Overall height of guardrail	3,420 (11' 3")

Boom length	5,100 (16' 9") 2-Piece boom	
Arm length	2,200 (7' 3")	2,600 (8' 6")
I	Overall length (Traveling position)	6,630 (21' 9")
I'	Overall length (Shipping position)	8,650 (28' 5")
J	Overall height of boom (Traveling position)	3,980 (13' 1")
J'	Overall height of boom (Shipping position)	2,900 (9' 6")
K	End of attachment to steering wheel	3,300 (10' 10")

## HW180 2-PIECE BOOM WORKING RANGE

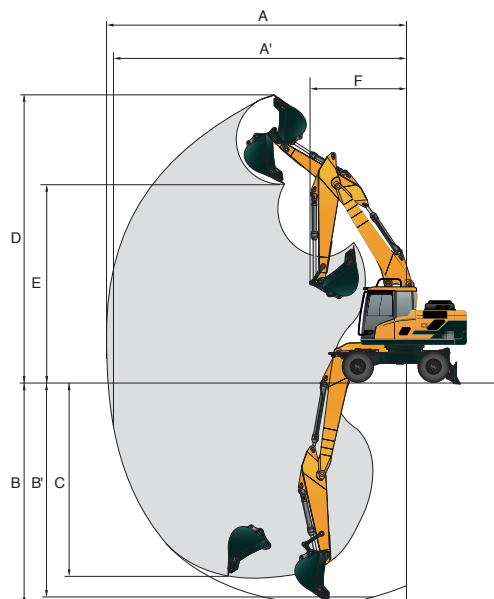

Unit : mm (ft-in)

Boom length	5,100 (16' 9") 2-Piece boom	
Arm length	2,200 (7' 3")	2,600 (8' 6")
A	Max. digging reach	8,760 (28' 9")
A'	Max. digging reach on ground	8,550 (28' 1")
B	Max. digging depth	5,220 (17' 2")
B'	Max. digging depth (8' level)	5,120 (16' 10")
C	Max. vertical wall digging depth	4,430 (14' 6")
D	Max. digging height	9,630 (31' 7")
E	Max. dumping height	6,930 (22' 9")
F	Min. front swing radius	3,100 (10' 2")

















# LIFTING CAPACITY













 Rating over-front  Rating over-side or 360 degrees

## HW180 2-PIECE BOOM

5.2 m (17' 1") 2-piece boom; 2.60 m (8' 6") arm equipped with 0.76 m<sup>3</sup> (SAE heaped) bucket and dozer blade down.

Load point height m (ft)	Load radius										At max. reach		
	1.5 m (5 ft)		3.0 m (10 ft)		4.5 m (15 ft)		6.0 m (20 ft)		7.5 m (25 ft)		Capacity		Reach m (ft)
													
7.5 m (25 ft)	kg										*3300	2890	6.57
	lb										*7280	6370	(21.6)
6.0 m (20 ft)	kg						*3340	3340			*3270	2120	7.70
	lb						*7360	7360			*7210	4670	(25.3)
4.5 m (15 ft)	kg						*3760	3250	*1800	*1800	*3320	1770	8.35
	lb						*8290	7170	*3970	*3970	*7320	3900	(27.4)
3.0 m (10 ft)	kg		*8680	*8680	*5510	4890	*4330	3080	*3250	2080	*3400	1600	8.66
	lb		*19140	*19140	*12150	10780	*9550	6790	*7170	4590	*7500	3530	(28.4)
1.5 m (5 ft)	kg		*6820	*6820	*6790	4500	*4940	2900	*4020	2000	*3490	1560	8.67
	lb		*15040	*15040	*14970	9920	*10890	6390	*8860	4410	*7690	3440	(28.4)
Ground Line	kg		*7760	*7760	*7490	4270	*5350	2760	*3800	1940	*3580	1630	8.37
	lb		*17110	*17110	*16510	9410	*11790	6080	*8380	4280	*7890	3590	(27.5)
-1.5 m (-5 ft)	kg	*7030	*7030	*10790	8070	*7480	4190	*5360	2710		*3620	1870	7.73
	lb	*15500	*15500	*23790	17790	*16490	9240	*11820	5970		*7890	4120	(25.4)
-3.0 m (-10 ft)	kg	*10330	*10330	*9820	8210	*6700	4240	*4660	2750		*3490	2460	6.63
	lb	*22770	*22770	*21650	18100	*14770	9350	*10270	6060		*7690	5420	(21.8)
-4.5 m (-15 ft)	kg		*6840	*6840	*4480	4450							
	lb		*15080	*15080	*9880	3810							

5.2 m (17' 1") 2-piece boom; 3.10 m (10' 2") arm equipped with 0.76 m<sup>3</sup> (SAE heaped) bucket and dozer blade down.

Load point height m (ft)	Load radius										At max. reach			
	1.5 m (5 ft)		3.0 m (10 ft)		4.5 m (15 ft)		6.0 m (20 ft)		7.5 m (25 ft)		Capacity		Reach m (ft)	
														
7.5 m (25 ft)	kg							*1900	*1900			*2940	2480	7.16
	lb							*4190	*4190			*6480	5470	(23.5)
6.0 m (20 ft)	kg							*2990	*2990			*2950	1880	8.20
	lb							*6590	*6590			*6500	4140	(26.9)
4.5 m (15 ft)	kg							*3360	3280	*2450	2150	*3010	1580	8.81
	lb							*7410	7230	*5400	4740	*6640	3480	(28.9)
3.0 m (10 ft)	kg		*7290	*7290	*4930	*4930	*3980	3090	*3340	2070	*3100	1430	9.10	
	lb		*16070	*16070	*10870	*10870	*8770	6810	*7360	4560	*6830	3150	(29.9)	
1.5 m (5 ft)	kg		*9480	8520	*6330	4550	*4660	2890	*3810	1980	3210	1390	9.11	
	lb		*20900	18780	*13960	10030	*10270	6370	*8400	4370	7080	3060	(29.9)	
Ground Line	kg		*8290	8050	*7250	4260	*5170	2740	*4050	1890	*3320	1440	8.83	
	lb		*18280	17750	*15980	9390	*11400	6040	*8930	4170	*7320	3170	(29.0)	
-1.5 m (-5 ft)	kg	*6560	*6560	*10300	7960	*7480	4130	*5330	2650	*3340	1860	*3410	1640	8.23
	lb	*14460	*14460	*22710	17550	*16490	9110	*11750	5840	*7360	4100	*7520	3620	(27.0)
-3.0 m (-10 ft)	kg	*9220	*9220	*10500	8050	*6980	4140	*4950	2660			*3400	2080	7.21
	lb	*20330	*20330	*23150	17750	*15390	9130	*10910	5860			*7500	4590	(23.7)
-4.5 m (-15 ft)	kg	*12750	*12750	*8080	*8080	*5420	4280					*3000	*3000	5.51
	lb	*28110	*28110	*17810	*17810	*11950	9440					*6610	*6610	(18.1)

1. Lifting capacity are based on SAE J1097 and ISO 10567.

2. Lifting capacity of the ROBEX series does not exceed 75% of tipping load with the machine on firm, level ground or 87% of full hydraulic capacity.

3. The load point is a hook (standard equipment) located on the back of the bucket.  
4. (\*) indicates load limited by hydraulic capacity.

ENGINE	STD	OPT
Cummins QSB 6.7 engine	●	
<b>HYDRAULIC SYSTEM</b>		
<b>Intelligent Power Control (IPC)</b>		
3-power mode, 2-work mode, user mode	●	
Variable Power Control	●	
Pump Flow Control	●	
Attachment Mode Flow Control		●
Engine Auto Idle	●	
Engine Auto Shutdown Control		●
Electronic Fan Control	●	
<b>CABIN &amp; INTERIOR</b>		
<b>ISO Standard cabin</b>		
Rise-up type windshield wiper	●	
Radio / USB player	●	
Handsfree mobile phone system with USB	●	
12 volt power outlet (24V DC to 12V DC converter)	●	
Electric horn	●	
All-weather steel cab with 360° visibility	●	
Safety glass windows	●	
Sliding fold-in front window	●	
Sliding side window (LH)	●	
Lockable door	●	
Hot & cool box	●	
Storage compartment & Ashtray	●	
Transparent cabin roof-cover	●	
Sun visor	●	
Door and cab locks, one key	●	
Mechanical suspension seat with heater	●	
Pilot-operated slidable joystick	●	
Console box height adjust system	●	
<b>Automatic climate control</b>		
Air conditioner & heater	●	
Defroster	●	
Starting Aid (air grid heater) for cold weather	●	
<b>Centralized monitoring</b>		
8" LCD display	●	
Engine speed or Trip meter/Accel.	●	
Engine coolant temperature gauge	●	
Max power	●	
Low speed/High speed	●	
Auto idle	●	
Overload	●	
Check Engine	●	
Air cleaner clogging	●	
Indicators	●	
ECO Gauges	●	
Fuel level gauge	●	
Hyd. oil temperature gauge	●	
Fuel warmer	●	
Warnings	●	
Communication error	●	
Low battery	●	
Clock	●	
Cabin lights		●
Cabin front window rain guard		●
Cabin roof-steel cover		●
<b>Seat</b>		
Adjustable air suspension seat with heater		●
<b>Cabin FOPS/FOG (ISO/DIS 10262) Level 2</b>		
FOPS (Falling Object Protective Structure) - ISO 3449 Level 2		●
FOG (Falling Object Guard)		●
<b>Cabin ROPS (ISO 12117-2)</b>		
ROPS (Roll Over Protective Structure)	●	

SAFETY	STD	OPT
Battery master switch	●	
Rearview camera		●
AAVM (Advanced Around View Monitoring)		●
Four front working lights	●	
Travel alarm		●
Rear work lamp		●
Beacon lamp		●
Automatic swing brake	●	
Boom holding system	●	
Arm holding system	●	
Safety lock valve for boom cylinder with overload warning device		●
Safety lock valve for arm cylinder		●
Swing Lock System		●
Four outside rearview mirrors	●	
<b>OTHER</b>		
<b>Booms</b>		
5.2 m; 17' 1" Mono	●	
5.1 m; 16' 9" 2-Piece		●
<b>Arms</b>		
2.2 m; 7' 3"		●
2.6 m; 8' 6"	●	
3.1 m; 10' 2"		●
Removable clean-out dust net for cooler	●	
Removable reservoir tank	●	
Fuel pre-filter	●	
Fuel warmer	Single	●
	Dual	●
Self-diagnostics system		●
Hi-mate (Remote Management System)	Mobile	●
	Satellite	●
	Dual	●
Batteries (2 x 12 V x 100 Ah)	●	
Fuel filler pump (50 l/min)		●
Single-acting piping kit (breaker, etc.)		●
Double-acting piping kit (clamshell, etc.)		●
Rotating Piping Kit		●
Quick coupler piping		●
Quick coupler		●
Accumulator for lowering work equipment	●	
Pattern change valve (2 patterns)		●
Fine Swing Control System		●
Tool kit		●
Auto cruiser system	●	
Travel pedal (2-way)		●
<b>UNDERCARRIAGE</b>		
Front dozer blade		●
Front - grapple rest, Rear - dozer blade		●
Rear dozer blade		●
Rear outrigger		●
Front and rear dozer blade		●
Front outrigger and rear dozer blade		●
Front and rear outrigger		●
Front dozer blade and rear outrigger		●
Tires-dual (10.00-20-16PR tube)	●	
Tires-dual (10.00-20 solid)		●
Fenders (Mudguards)		●

STD = Standard  
OPT = Optional

- \* Standard and optional equipment may vary. Contact your Hyundai dealer for more information.
- \* The machine may vary according to International standards.
- \* The photos may include attachments and optional equipment that are not available in your area.
- \* Materials and specifications are subject to change without advance notice.
- \* All imperial measurements rounded off to the nearest pound or inch.