

Robex

25z-9AK

With Tier 4 Engine installed

MOVING YOU FURTHER

HYUNDAI HEAVY INDUSTRIES



 **HYUNDAI**

PRIDE AT WORK

Hyundai Heavy Industries strives to build state-of-the-art earthmoving equipment to give every operator maximum performance, optimal controllability, versatile machine settings and proven technology.

Be proud of your work with Hyundai!



*Photo may include optional equipment.

Robex 25Z-9AK

Machine Walk-Around



Engine Technology

Proven, reliable, fuel efficient, low emission and low noise Kubota D1305 Tier 4 engine.

Robust Upper and Lower Frame

The structure of the upper frame is designed to absorb high stress and to resist inherent external influences. An X-type center frame and a reinforced box section track frame provide exceptional strength and longer service life to withstand tough working conditions.

Control System

Control devices are well located for increased operator's comfort and a higher productivity. A safety lever on the left side console is installed to prevent exiting the cabin with active hydraulic control levers.

Advanced Hydraulic System

The hydraulic system of the R25Z-9AK is designed for fast operation combined with high controllability.

Comfortable and Durable Cabin

The spacious cabin is ergonomically designed, with low noise level and high visibility. Canopy & cabin frame are complying with international standard TOPS, ROPS & FOPS, for maximum protection of the operator.

Operator Convenience

R25Z-9AK cabin equipped with a suspension seat, foldable pedals and various storage space for advanced operator comfort. The monitoring system displays warning indicators, water temperature gauge, fuel gauge and hour meter to check the full status of the machine at a single glance.

Easy and Simple Maintenance

With open access of doors, covers and engine hoods, air cleaner and centralized grease fittings the machine is a pleasure to maintain.

Extended Life of Components

Long-life hydraulic filters, long-life hydraulic oil, long-lasting shims and long-lasting bushes are reducing operation costs.

PRECISION

Innovative hydraulic system technologies make the 9A series excavator fast, smooth and easy to control.



*Photo may include optional equipment.



Boom Swing

The R25Z-9AK's boom swing function is designed for efficient work in congested residential and urban areas. The boom can be offset left or right within an operating range.



Easy to transport

The new R25Z-9AK can be moved on a small trailer, with a simple car driver's licence. No truck is required to easily transport the machine to a jobsite, and back to the yard.

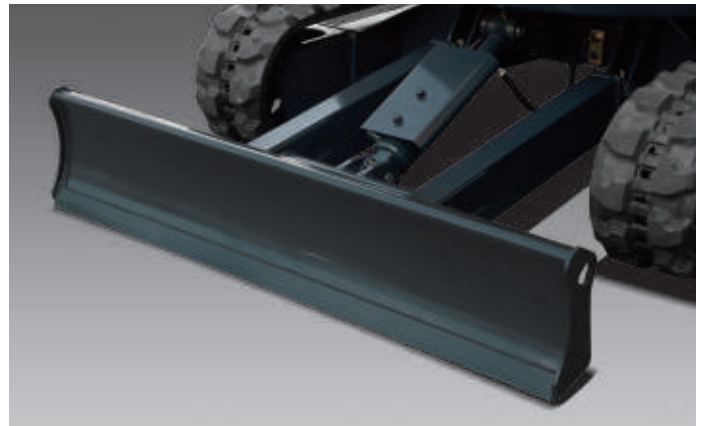

Dozer Blade

Large dozer blade provides added versatility, work efficiency and stability for the job.

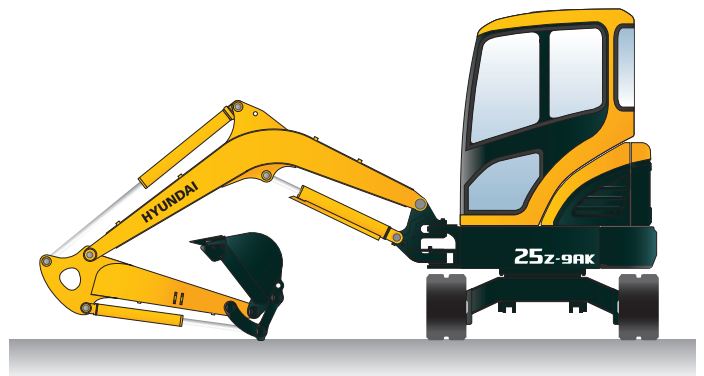

Zero-tail Swing

R25Z-9AK's short tail swing radius allows the operator work in confined areas like close to buildings on roadways, and in urban areas. This compact radius design provides easy and efficient operation in any limited space work environment.



Lever Pattern Change Valve (option)

Joystick control pattern can be changed easily through a pattern change valve.

PERFORMANCE

The 9A series excavators are offering optimal performance and maximum productivity.



*Photo may include optional equipment.



Cylinder Covers

Cylinders of boom and dozer blade are provided with covers for extra protection.

Structural Strength

The R25Z-9AK cabin structure is designed with slimmer but stronger tubing for more safety and better visibility. Low-stress and high strength steel is welded to form a strong and stable lower frame. Structural durability is analyzed and tested by FEM-analysis (Finite Elements Method) and long-term durability tests.

Kubota D1305

Emissions: The most compact multi-cylinder liquid cooled industrial diesel engines comply with EPA Tier 4 Emission regulations without additional After Treatment Tools. This engine meets standards over the NRTC and NTE requirements.

Lower Noise Level: The half-float valve cover and MoS₂ coated piston reduce noise levels and vibration.

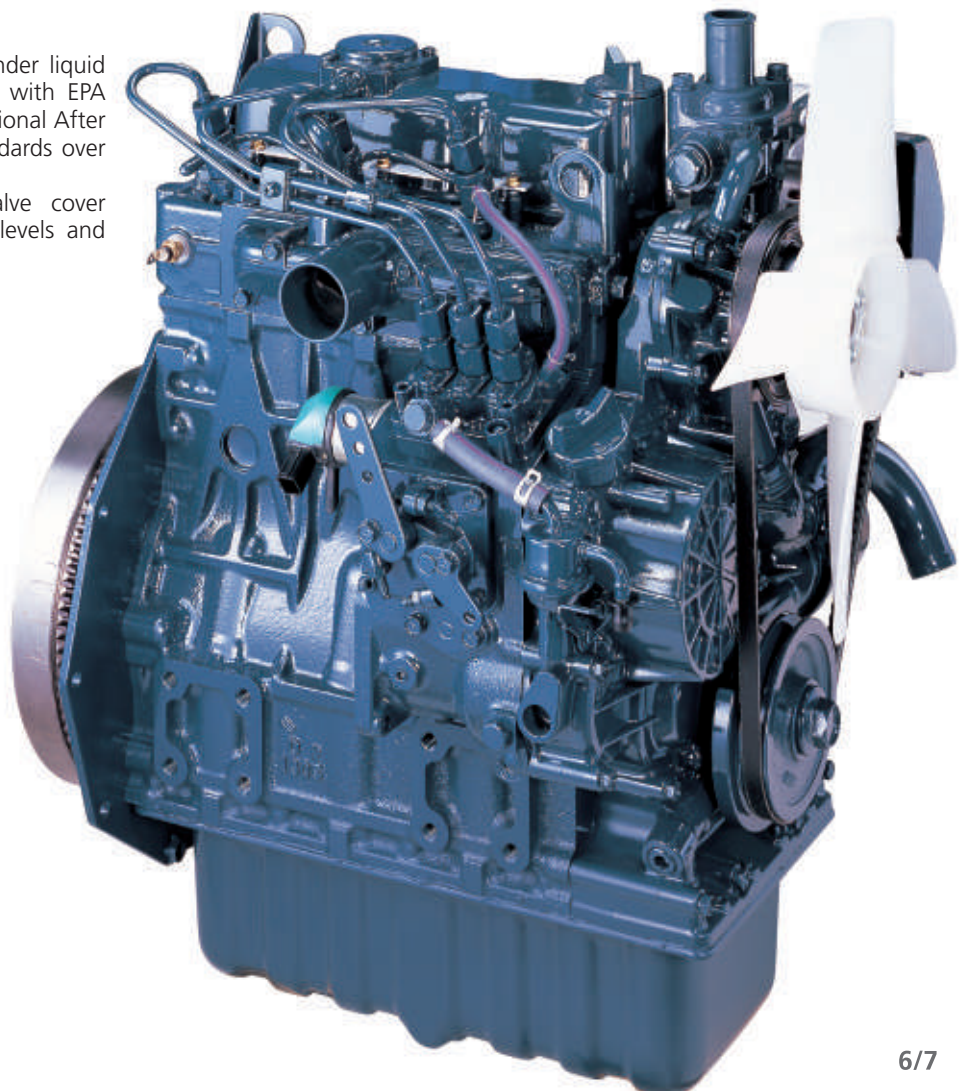

PREFERENCE

An operator, who sets his machine to his needs, takes pleasure in his work. Operators can fully customize their work environment and operating preferences to fit their individual needs.



*Photo may include optional equipment.



Monitor

The monitoring system of the R25Z-9AK provides the operator with machine status information, including: engine oil pressure lamp, battery charge lamp, engine coolant temperature and a fuel gauge.

Comfortable Operating Cabin

In a 9 series cabin, you can adjust the seat, console and armrests to suit your preferred comfort level.

1. The pedals (travel - boom offset - attachment) are installed in a convenient position and can be folded in to gain extra foot space.
2. Different sizes of cup holders.
3. Operator's belongings can be stored in a lockable storage box under the seat.
4. Armrests to increase operator's comfort.
5. Slidable front window can be opened easily and is kept safely in open position (cabin Type)

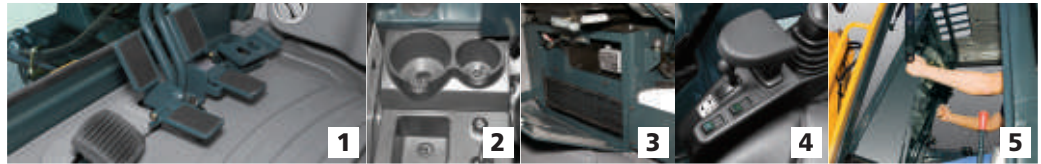

Stressless

Work is stressful enough; your working environment should be stressless. Hyundai's R25Z-9AK provides improved cabin interior and additional storage space to minimize the stress of the operator.

Operator Comfort

The left and right joysticks are ergonomically placed for convenient operation. The joysticks have enough space to install additional option switches. A safety lever is installed to prevent unexpected activation of the hydraulic attachments. When the safety lever is positioned upright, hydraulic functions are disengaged.



A tiltable left-side console make the operator easier to enter and exit the cab.



PROFITABILITY

9A series machines are designed to maximize profitability through improved fuel efficiency, enhanced service features and long-lasting components.



*Photo may include optional equipment.



Easy to Change Air Cleaner

The R25Z-9AK is equipped with a durable plastic air cleaner, designed for easy maintenance.



Selector Valve for Single or Double Acting Piping

Double Acting Pipe located on front of the Fuel Tank for easy to access and control.

Lever direction

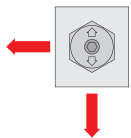

Vertical : Single acting piping (Breaker)
Horizontal : Double acting piping (clamshell)



Centralized Grease Fittings

Centralized grease fittings for faster and easier maintenance.



Easy Maintenance Access

The R25Z-9AK was built with accessibility in mind. All doors, covers and hoods are designed for full open accessibility. The R25Z-9AK offers plenty of space to complete regular maintenance.



Proportional Auxiliary Hydraulic System

- Opt: Proportional Control Switch for better speed control
- Enlarge the Operation Convenience



Long-Life Components

9A series excavators were designed with bushings designed for long-life lube intervals (250 hrs) & polymer shims (wear resistant, noise reducing), long-life hydraulic filters (1,000hrs), long-life hydraulic oil (5,000hrs), more efficient cooling systems and integrated preheating systems which extend service intervals, minimize operating costs and reduce machine down time.

Specifications R25Z-9AK

ENGINE

MODEL	KUBOTA D1305		
Type	4 Cycle Diesel engine, in line, water cooled		
Rated flywheel horse power			
SAE	J1995 (gross)	24.9 HP (18.5 kW) / 2,350 rpm	
	J1349 (net)	23.2 HP (17.3 kW) / 2,350 rpm	
DIN	6271/1 (gross)	25.2 PS (18.5 kW) / 2,350 rpm	
	6271/1 (net)	23.5 PS (17.3 kW) / 2,350 rpm	
Max. torque	8.3 kgf.m (60.17 lbf.ft) / 1,600 rpm		
Bore x stroke	78 mm x 88 mm (3.07" x 3.46")		
Piston displacement	1,261 cc (76.9 in ³)		
Batteries	12 V - 80 Ah		
Starting motor	12 V - 1.4 kW		
Alternator	12 V - 40 A		

HYDRAULIC SYSTEM

MAIN PUMP	
Type	Variable displacement piston pumps
Max. flow	2 x 27.6 + 19.6 ℓ/min
Sub-pump for pilot circuit	Gear pump
HYDRAULIC MOTORS	
Travel	Two speed axial piston motor with counter balance valve and parking brake
Swing	Axial piston motor with automatic brake
RELIEF VALVE SETTING	
Implement circuits	220 Kgf/cm ² (3,130 psi)
Travel circuit	220 Kgf/cm ² (3,130 psi)
Swing circuit	175 Kgf/cm ² (2,489 psi)
Pilot circuit	30 Kgf/cm ² (430 psi)
Service valve	Installed

HYDRAULIC CYLINDERS

No. of cylinder- bore x stroke	
Boom	75 x 565 mm (3.0" x 22.2")
Arm	70 x 500 mm (2.8" x 19.7")
Bucket	55 x 420 mm (2.16" x 16.5")
Boom swing	75 x 400 mm (3.0" x 15.7")
Dozer blade	85 x 140 mm (3.3" x 5.5")

OPERATOR'S CAB

Noise Levels (dynamic value)	
Outside cabin - LwA	94dB
Inside cabin - LpA	75dB

COOLANT & LUBRICANT CAPACITY

	liter	US gal	UK gal
Fuel tank	30	7.9	6.6
Engine coolant	5.0	1.3	1.0
Engine oil	5.9	1.6	1.3
Hydraulic tank	27	7.1	5.9

TRAVEL LEVERS

Traveling and steering : Two levers with foldable pedals.

HYDRAULIC CONTROLS

Type	Two joysticks with one safety lever	
Pilot control	(LH): Swing and arm, (RH): Boom and bucket with horn (ISO)	
Engine throttle	Mechanical, cable type	

SWING SYSTEM

Swing motor	Axial piston motor
Swing reduction	Planetary gear reduction
Swing bearing lubrication	Grease-bathed
Swing brake	Wet disc
Swing speed	9.1 rpm

DRIVES & BRAKES

Max. travel speed (high) / (low)	4.3 km/h / 2.4 km/h ((2.7 mph) / (1.6 mph))
Maximum traction force	2.4 ton
Maximum gradeability	30°
Parking brake	Wet disc

DIGGING FORCE (ISO)

Bucket	2,150 kgf
	21.1 kN
	4,740 lbf
Arm [Long Arm]	1,490 [1,310] kgf
	14.6 [12.8] kN
	3,280 [2,890] lbf

OPERATING WEIGHT (APPROXIMATE)

Operating weight, including 1,945 mm (6' 5") boom, 1,120 mm (3' 8") arm, SAE heaped 0.07 m³ (0.1 yd³) excavator bucket, lubricant, coolant, full fuel tank, full hydraulic tank and all standard equipments.

Shoe Width	Rubber shoe 250 mm (10")	
Operating Weight	Cabin	2,580 kg (5,690 lb)
	Canopy	2,430 kg (5,360 lb)
Ground Pressure	Cabin	0.32 kg/cm ² (4.6 psi)
	Canopy	0.30 kg/cm ² (4.34 psi)

UNDERCARRIAGE

X-leg type center frame is integrally welded with reinforced box-section track frames. The undercarriage includes lubricated rollers, track adjusters with shock absorbing springs and sprockets and rubber shoes.

Center frame	X-leg type
Track frame	Pentagonal box type
No. of carrier roller on each side	1
No. of track roller on each side	3

Dimensions & Working Ranges

DIMENSIONS R25Z-9AK

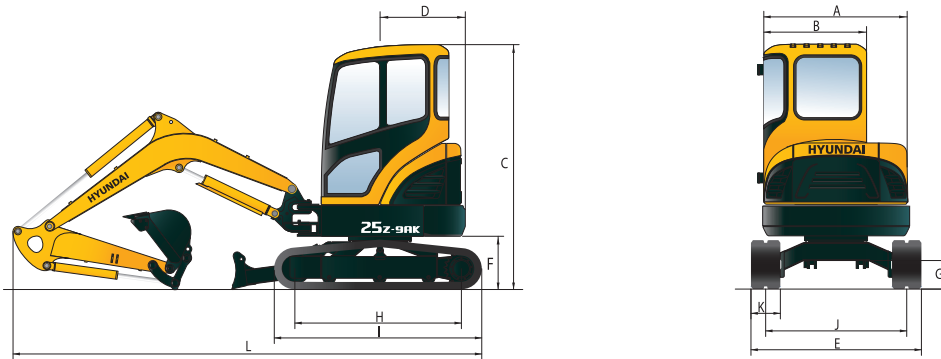

mm (ft · in)

A Overall width of upper structure	1,485 (4' 10")	G Ground clearance	290 (11")
B Overall width of cab	1,050 (3' 5")	H Tumbler distance	1,490 (4' 11")
C Overall height of cab	2,500 (8' 2")	I Track length	1,910 (6' 3")
D Tail swing radius - standard counterweight	775 (2' 7")	J Track gauge	1,250 (4' 1")
Tail swing radius - additional counterweight	875 (2' 10")	K Track shoe width	250 (10")
E Overall width	1,500 (4' 11")	L Overall length - Standard Arm	4,030 (13' 3")
F Clearance under counterweight	510 (1' 67")	Overall length - Long Arm	4,100 (13' 5")

WORKING RANGES R25Z-9AK

mm (ft · in)

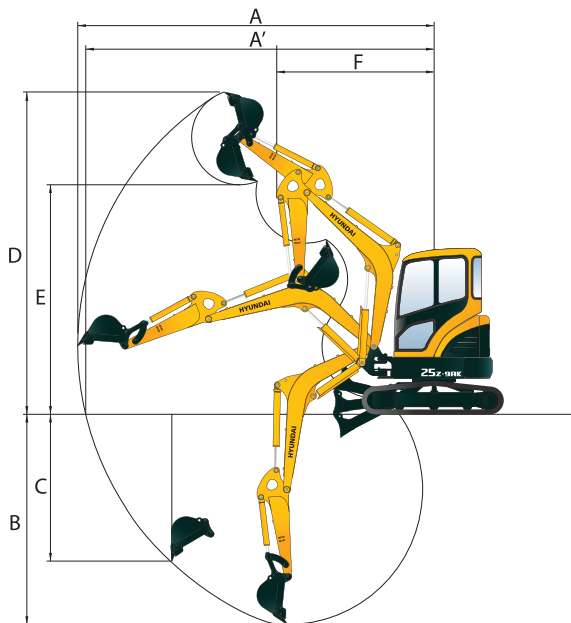

Boom length	1,945 (6' 5")
Arm length	1,120 (3' 8") *1,350 (4' 5")
A Max. digging reach	4,480 (14' 8") *4,680 (15' 4")
A' Max. digging reach on ground	4,340 (14' 3") *4,540 (14' 11")
B Max. digging depth	2,420 (7' 11") *2,645 (8' 8")
C Max. vertical wall digging depth	1,460 (4' 9") *1,605 (5' 3")
D Max. digging height	4,150 (13' 7") *4,235 (13' 11")
E Max. dumping height	2,930 (9' 7") *3,030 (9' 11")
F Min. front swing radius	1,980 (6' 6") *1,970 (6' 6")











* Long arm

Lifting Capacities











 Rating over-front  Rating over-side or 360 degrees

R25Z-9AK

Boom : 1.945 m (6' 5") / Arm : 1.12 m (3' 8") / Bucket : 0.07 m³ (0.01 yd³) SAE heaped / Dozer Down / 250 mm (9.8") Rubber track / Cabin Type / Standard counterweight

Load point height m (ft)		Load radius								At max. reach		
		2.0 m(5 ft)		2.5 m(10 ft)		3.0 m(10 ft)		3.5 m(10 ft)		Capacity		Reach
												m (ft)
3.5 m	kg									*560	450	3.07
10 ft	lb									*1230	990	(10.1)
3.0 m	kg					*590	460			*570	340	3.59
10 ft	lb					*1300	1010			*1260	750	(11.8)
2.5 m	kg					*590	460	*600	350	*590	290	3.92
10 ft	lb					*1300	1010	*1320	770	*1300	640	(12.9)
2.0 m	kg			*670	610	*650	450	*650	350	*600	260	4.13
5 ft	lb			*1480	1340	*1430	990	*1430	770	*1320	570	(13.5)
1.5 m	kg	*1180	860	*890	590	*770	440	*700	340	*620	240	4.24
5 ft	lb	*2600	1900	*1960	1300	*1700	970	*1540	750	*1370	530	(13.9)
1.0 m	kg	*1760	800	*1150	560	*900	420	*770	330	*640	240	4.26
5 ft	lb	*3880	1760	*2540	1230	*1980	930	*1700	730	*1410	530	(14.0)
0.5 m	kg	*1750	770	*1340	540	*1010	410	*830	320	*660	240	4.19
0 ft	lb	*3860	1700	*2950	1190	*2230	900	*1830	710	*1460	530	(13.7)
Ground Line	kg	*1990	760	*1430	530	*1070	400	*850	320	*680	260	4.04
	lb	*4390	1680	*3150	1170	*2360	880	*1870	710	*1500	570	(13.3)
-0.5 m	kg	*2030	760	*1420	530	*1060	400	*820	320	*690	290	3.78
-0 ft	lb	*4480	1680	*3130	1170	*2340	880	*1810	710	*1520	640	(12.4)
-1.0 m	kg	*1810	770	*1290	530	*960	400			*690	350	3.36
-5 ft	lb	*3990	1700	*2840	1170	*2120	880			*1520	770	(11.0)
-1.5 m	kg	*1410	780	*990	540					*610	500	2.67
-5 ft	lb	*3110	1720	*2180	1190					*1340	1100	(8.8)
-2.5 m	kg									*480	370	3.38
-10 ft	lb									*1060	820	(11.1)

Boom : 1.945 m (6' 5") / Arm : 1.12 m (3' 8") / Bucket : 0.07 m³ (0.01 yd³) SAE heaped / Dozer Up / 250 mm (9.8") Rubber track / Cabin Type / Standard counterweight

Load point height m (ft)		Load radius								At max. reach		
		2.0 m(5 ft)		2.5 m(10 ft)		3.0 m(10 ft)		3.5 m(10 ft)		Capacity		Reach
												m (ft)
3.5 m	kg									440	440	3.07
10 ft	lb									970	970	(10.1)
3.0 m	kg					450	450			330	330	3.59
10 ft	lb					990	990			730	730	(11.8)
2.5 m	kg					450	450	340	340	280	280	3.92
10 ft	lb					990	990	750	750	620	620	(12.9)
2.0 m	kg			610	600	450	440	340	340	250	250	4.13
5 ft	lb			1340	1320	990	970	750	750	550	550	(13.5)
1.5 m	kg	870	840	590	580	430	430	330	330	240	240	4.24
5 ft	lb	1920	1850	1300	1280	950	950	730	730	530	530	(13.9)
1.0 m	kg	810	780	560	550	420	410	320	320	230	230	4.26
5 ft	lb	1790	1720	1230	1210	930	900	710	710	510	510	(14.0)
0.5 m	kg	780	750	540	530	400	400	320	320	240	240	4.19
0 ft	lb	1720	1650	1190	1170	880	880	710	710	530	530	(13.7)
Ground Line	kg	770	740	530	520	400	390	310	310	250	250	4.04
	lb	1700	1630	1170	1150	880	860	680	680	550	550	(13.3)
-0.5 m	kg	770	740	530	520	390	390	310	310	280	280	3.78
-0 ft	lb	1700	1630	1170	1150	860	860	680	680	620	620	(12.4)
-1.0 m	kg	770	750	530	520	400	390			340	340	3.36
-5 ft	lb	1700	1650	1170	1150	880	860			750	750	(11.0)
-1.5 m	kg	790	760	540	530					500	490	2.67
-5 ft	lb	1740	1680	1190	1170					1100	1080	(8.8)
-2.5 m	kg									360	360	3.38
-10 ft	lb									790	790	(11.1)













- Lifting capacity is based on SAE J1097, ISO 10567.
- Lifting capacity of the Robex Series does not exceed 75% of the tipping load with the machine on firm, level ground or 87% of full hydraulic capacity.
- The load point is a hook located on the back of the bucket.
- (*) indicates the load limited by hydraulic capacity.

Lifting Capacities













 Rating over-front  Rating over-side or 360 degrees

R25Z-9AK

Boom : 1.945 m (6' 5") / Arm : 1.35 m (4' 5") / Bucket : 0.07 m³ (0.01 yd³) SAE heaped / Dozer Down / 250 mm (9.8") Rubber track / Cabin Type / Standard counterweight

Load point height m (ft)		Load radius										At max. reach			
		2.0 m(5 ft)		2.5 m(10 ft)		3.0 m(10 ft)		3.5 m(10 ft)		4.0 m(15 ft)		Capacity		Reach	
														m (ft)	
3.5 m	kg												*500	380	3.39
10 ft	lb												*1100	840	(11.1)
3.0 m	kg												*510	300	3.85
10 ft	lb												*1120	660	(12.6)
2.5 m	kg							*540	350				*530	260	4.15
10 ft	lb							*1190	770				*1170	570	(13.6)
2.0 m	kg					*550	450	*570	350				*550	240	4.34
5 ft	lb					*1210	990	*1260	770				*1210	530	(14.2)
1.5 m	kg			*740	600	*670	440	*630	340	*610	270		*570	220	4.44
5 ft	lb			*1630	1320	*1480	970	*1390	750	*1340	600		*1260	490	(14.6)
1.0 m	kg	*1480	820	*1010	570	*820	430	*710	330	*650	260		*590	220	4.46
5 ft	lb	*3260	1810	*2230	1260	*1810	950	*1570	730	1430	570		*1300	490	(14.6)
0.5 m	kg	*1930	780	*1250	550	*950	410	*790	320	*680	260		*610	220	4.40
0 ft	lb	*4250	1720	*2760	1210	*2090	900	*1740	710	*1500	570		*1340	490	(14.4)
Ground Line	kg	*2020	760	*1390	530	*1040	400	*840	310				*630	230	4.25
	lb	*4450	1680	*3060	1170	*2290	880	*1850	680				*1390	510	(13.9)
-0.5 m	kg	*2090	750	*1430	520	*1070	390	*840	310				*660	250	4.01
-0 ft	lb	*4610	1650	*3150	1150	*2360	860	*1850	680				*1460	550	(13.2)
-1.0 m	kg	*1950	750	*1360	520	*1020	390						*670	300	3.64
-5 ft	lb	*4300	1650	*3000	1150	*2250	860						*1480	660	(11.9)
-1.5 m	kg	*1650	760	*1160	530								*660	400	3.06
-5 ft	lb	*3640	1680	*2560	1170								*1460	880	(10.0)
-2.0 m	kg	*1040	790												
-5 ft	lb	*2290	1740												
-2.5 m	kg												*510	420	(3.07)
-10 ft	lb												*1120	930	(10.1)

Boom : 1.945 m (6' 5") / Arm : 1.35 m (4' 5") / Bucket : 0.07 m³ (0.01 yd³) SAE heaped / DozerUp / 250 mm (9.8") Rubber track / Cabin Type / Standard counterweight

Load point height m (ft)		Load radius										At max. reach			
		2.0 m(5 ft)		2.5 m(10 ft)		3.0 m(10 ft)		3.5 m(10 ft)		4.0 m(15 ft)		Capacity		Reach	
														m (ft)	
3.5 m	kg												370	370	3.39
10 ft	lb												820	820	(11.1)
3.0 m	kg												290	290	3.85
10 ft	lb												640	640	(12.6)
2.5 m	kg							340	340				250	250	4.15
10 ft	lb							750	750				550	550	(13.6)
2.0 m	kg					450	440	340	340				230	230	4.34
5 ft	lb					990	970	750	750				510	510	(14.2)
1.5 m	kg			600	590	440	430	330	330	260	260		220	220	4.44
5 ft	lb			1320	1300	970	950	730	730	570	570		490	490	(14.6)
1.0 m	kg	830	800	570	560	420	420	320	320	260	260		210	210	4.46
5 ft	lb	1830	1760	1260	1230	930	930	710	710	570	570		460	460	(14.6)
0.5 m	kg	790	760	540	530	410	400	310	310	250	250		210	220	4.40
0 ft	lb	1740	1680	1190	1170	900	880	680	680	550	550		460	490	(14.4)
Ground Line	kg	770	740	530	520	390	390	310	310				220	230	4.25
	lb	1700	1630	1170	1150	860	860	680	680				490	510	(13.9)
-0.5 m	kg	760	730	520	510	390	380	300	300				250	250	4.01
-0 ft	lb	1680	1610	1150	1120	860	840	660	660				550	550	(13.2)
-1.0 m	kg	760	730	520	510	390	380						290	290	3.64
-5 ft	lb	1680	1610	1150	1120	860	840						640	640	(11.9)
-1.5 m	kg	770	740	530	520								390	390	3.06
-5 ft	lb	1700	1630	1170	1150								860	860	(10.0)
-2.0 m	kg	790	760												
-5 ft	lb	1740	1680												
-2.5 m	kg												410	410	(3.07)
-10 ft	lb												900	900	(10.1)

- Lifting capacity is based on SAE J1097, ISO 10567.
- Lifting capacity of the Robex Series does not exceed 75% of the tipping load with the machine on firm, level ground or 87% of full hydraulic capacity.
- The load point is a hook located on the back of the bucket.
- (*) indicates the load limited by hydraulic capacity.

STANDARD EQUIPMENT R25Z-9AK

ISO standard cabin

Cabin	ROPS (ISO 3471)
	FOPS (ISO 3449)
	FOG (ISO 10262 Level I)
	TOPS (ISO 12117)

All-weather steel cab with all-around visibility

Safety glass windows

Sliding fold-in front window

Sliding side window

Lockable door

Accessory box

Centralized monitoring

Gauges

Fuel level gauge
Engine coolant temperature gauge

Warning lamps

Engine oil pressure
Engine coolant temperature
Preheat engine
Low battery
Air cleaner clogging
Fuel empty

Door and locks, one key fits all

Radio / USB player

Mechanical suspension seat with seat belt

Console box tilting system (LH.)

Two front working lights

Electric horn

Battery (1 x 12 V x 80 Ah)

Battery master switch

Automatic swing brake

Removable reservoir tank

Water separator, fuel line

Mono boom (1.945 m; 6' 5")

Arm (1.12 m; 3' 8")

Rubber crawler (250 mm; 10")

Single acting piping (Breaker, etc)

Double acting piping (Clamshell, etc)

OPTIONAL EQUIPMENT R25Z-9AK

ISO standard canopy

Canopy	ROPS (ISO 3471)
	FOPS (ISO 3449)
	FOG (ISO 10262 Level I)
	TOPS (ISO 12117)

Beacon lamp

Accumulator, work equipment lowering

Travel alarm

Quick coupler

Tool kit

Long arm (1.35 m; 4' 5")

Heater & defroster

Lever pattern change valve

Additional counterweight

- * Standard and optional equipment may vary. Contact your Hyundai dealer for more information. The machine may vary according to international standards.
- * The photos may include attachments and optional equipment that are not available in your area.
- * Materials and specifications are subject to change without advance notice.
- * All imperial measurements rounded off to the nearest pound or inch.

PLEASE CONTACT

