

MOVING YOU FURTHER

HX430L

With Tier 4 final / Stage IV Engine installed



*Photo may include optional equipment.

Net Power

SAE J1349 / 267 kW (358 HP) at 1,800 rpm

Gross Power

SAE J1995 / 277 kW (372 HP) at 1,800 rpm

Travel Speed

5.3 km/h (3.41 mph) / 3.0 km/h (2.23 mph)

Operating Weight

44,120 kg / 97,270 lb





RULE THE GROUND

The HX Series excavators are products of HHI's spirit of initiative, creativity and strong drive. HHI's engineers, who are the best in the industry, have worked tirelessly to offer a zero-defect product. The new HX Series reflects customers' needs in the field gleaned by thorough monitoring. They maximize fuel efficiency and performance proven by rigorous field tests and quality control.





HYUNDAI

*Photo may include optional equipment.

RULE THE GROUND

The HX series exceeds customers' expectation!
Become a true leader on the ground with HHI's HX series.



WORK MAX, WORTH MAX

- ECO Gauge
- IPC (Intelligent Power Control)
- New Variable Power Control
- Electronic Viscous Fan Clutch
- Attachment Flow Control (Option)
- New Cooling System with Increased Air Flow
- Enlarged Air Inlet with Grill Cover
- One Pedal Travel Straight (Option)
- Cycle Time Improvement
- Boom Floating Control (Option)



MORE RELIABLE, MORE SUSTAINABLE

- Durable Cooling Module
- Reinforced Pin, Bush and Polymer Shim
- Reinforced Durability of Upper and Lower Structure and Attachments
- Wear Resistant Cover Plate
- Hi-grade (High-pressure) Hoses



INFOTAINMENT FRONTIER

- Intelligent and Wide Cluster
- Haptic Control
- Wi-Fi Direct with Smart Phone (Miracast)
- Centralized Controller
- Proportional Auxiliary Hydraulic System
- New Audio System
- New Air Conditioning System



HX430 L



MODERN COMFORT, SIMPLE AND SAFE SOLUTION

- AAVM (Advanced Around View Monitoring) Camera System (Option)
- Easy Access to DEF/AdBlue® Supply System
- Hi-mate (Remote Management System)
- Cab Suspension Mount
- Swing Lock System (Option)
- Fine Swing Control (Option)

*Photo may include optional equipment.

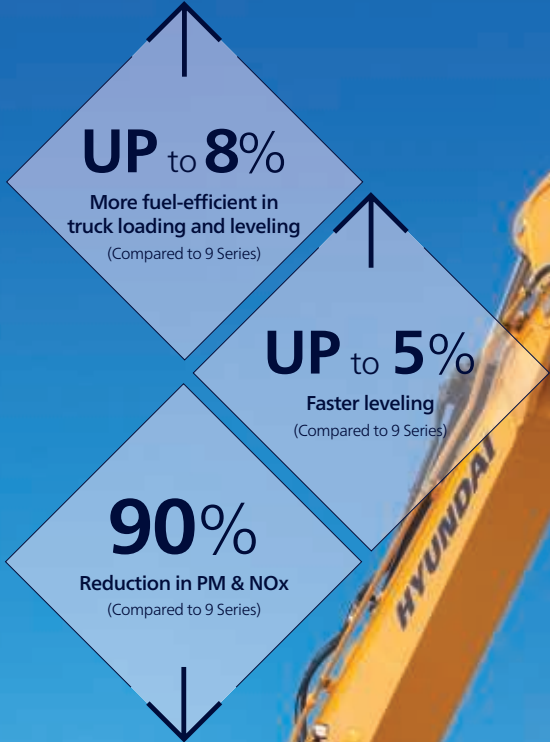

UP to 8%
More fuel-efficient in
truck loading and leveling
(Compared to 9 Series)

UP to 5%
Faster leveling
(Compared to 9 Series)

90%
Reduction in PM & NOx
(Compared to 9 Series)

*Photo may include optional equipment.

Cycle Time Improvement

The HX Series provides higher productivity on the site by faster operation: it levels up to 5% faster than the 9 Series.

Boom Floating Control (Option)

In order to achieve efficient leveling work by arm-in and arm-out operation with the boom fixed, the HX Series applies boom floating control, allowing stable operation even in high-load work.

WORK MAX, WORTH MAX

Fuel Efficient System, Allows Great Performance

The HX Series has an eco-friendly, high-performance engine which ensures both excellent fuel efficiency and high power. With outstanding operating performance proven by rigorous tests at various work sites, it will satisfy any customer's needs.



ECO Gauge

ECO Gauge enable economic operation of machines. The gauge level and color displays engine torque and fuel efficiency level. On top of that, the status of fuel consumption such as average rate and the total amount of fuel consumed are displayed. Hourly and daily based fuel consumption can be checked in the detailed menu as well.



IPC (Intelligent Power Control)

The IPC controls power control depending on work environments. Its mode can be selected and released on the monitor. On the excavation mode, pump flow can be easily controlled by a lever, reducing fuel consumption.

New Variable Power Control

The HX Series minimizes equipment input and output control signals to improve fuel efficiency. Its three-stage Power mode ensures the highest performance in any operating environment.

- * P (power) mode: Maximizes speed and power of the equipment for heavy load work.
- * S (standard) mode: Optimizes performance and fuel efficiency of the equipment for general load work.
- * E (economy) mode: Improves the control system for light load work.

Electronic Viscous Fan Clutch

The electronic fan clutch reduces noise during operation by precisely controlling RPM depending on the hydraulic oil and coolant temperature of the working vehicle, and minimizes fuel consumption. It is also possible to shorten the warm up time of hydraulic oil.



Attachment Flow Control (Option)

The HX Series improves pump flow rate by independent control of two pumps. It optimizes attachments for effective flow rate setting depending on attachments (ten breaker types and ten crusher types), enabling various operations matching the site environments.



New Cooling System with Increased Air Flow

With the three-floor stacked cooling module improving air inflow, the HX Series provides excellent cooling performance by increasing heat dissipation and can be easily cleaned.

Enlarged Air Inlet with Grill Cover

Enlarged vent hole of the air inlet side cover and fine net grill to prevent penetration of foreign materials further improve durability.

One Pedal Travel Straight (Option)

One Pedal Travel Straight (Option) is available for customers' convenience when long distance traveling or combination of attachment work with traveling is necessary.

MORE RELIABLE, MORE SUSTAINABLE

New Exterior Design for Robustness and Safety

The true value of the HX Series lies in its durability. The robust upper and lower frame structure that can endure external shock and high-load work and the attachments whose performance was proven by rigorous tests further show the real value of the HX Series in tough working environments and promise higher productivity.



Durable Cooling Module

The HX Series has a durable cooling module that passed stringent tests, demonstrating the highest productivity in tough working environments.



Reinforced Pin, Bush and Polymer Shim

The HX series improves lubricity of connecting parts between the equipment and attachments. Gaps with attachments are minimized by wear-resistant long-life pins, bushes and polymer shims, supporting the highest performance with invariable durability.

Wear Resistant Cover Plate

A wear-resistant cover plate is installed at the end of the arm to minimize abrasion on the connector between the arm and the bucket. Reduction of vibration of the buckets enables more stable operation even in high-load work.



Reinforced Durability of Upper and Lower Structure and Attachments

The upper and lower structure and attachments of the HX Series have higher durability than demanded on the site, as proven through numerous tests including road tests and virtual simulation. The wear resistance of the bucket has been improved by use of new material.



*Photo may include optional equipment.

Hi-grade (High-pressure) Hoses

The HX Series uses high-pressure hoses with improved heat and pressure resistance, greatly increasing the durability of the equipment.



New Air Conditioning System

With further improved air conditioning and heating, the HX Series increases the APTC capacity by 15% to provide a pleasant environment for operators all the time. The ventilation was designed such that warm and cool air even reach operators' faces (increasing their work satisfaction) or allowing pleasant working environment.

INFOTAINMENT FRONTIER

Enhanced Instrument Panel for Easier Monitoring

Many electronic functions are concentrated on the most convenient spot for operators to ensure work efficiency. The highly-advanced infotainment system, a product of HHI's intensive information technology, enables both productivity and pleasant work at the same time! The HX Series of HHI provides higher value and pleasure to customers.



Intelligent and Wide Cluster

The 8-inch capacitive-type display (like smartphone display) of the HX Series is 30% larger than the previous model, delivering excellent legibility. The centralized switches on the display allow convenience of checking the urea level and temperature outside the cabin. The audio AUX, air conditioner, heater interoperation, wiper, lamps, overload warnings, travel alarm and inclination sensor also maximize operator's convenience.

Wi-Fi Direct with Smart Phone (Miracast)

The Miracast system based on Wi-Fi of the operator's smart phone enables easy and convenient use of various features of the smart phone on the big screen including navigation, web surfing, viewing of videos, and listening to music. (For Android mobile phone now)

Proportional Auxiliary Hydraulic System

- Opt: Proportional control switch for better speed control
- Enlarge the operation convenience



Haptic Control

The integrated jog shuttle-type haptic controller applies to the accelerator, remote air conditioner controller and operation of the cluster, allowing convenient operation. In the event of failure of the haptic switch, the emergency mode is activated on the cluster to ensure fail-safe function.



New Audio System

Radio player, USB-based MP3 player, integrated Bluetooth hands-free feature, and built-in microphone allow convenient phone calls while in work and in transit. The radio player was moved to the right side from the rear, allowing easier access.

MODERN COMFORT, SIMPLE AND SAFE SOLUTION

New Cabin for More Comfort

Low noise, low vibration, and ergonomic design make the cabin space more comfortable and pleasant! With focus on safety and convenience of operators, the HX Series allows rapid and safe equipment inspection anytime and anywhere, providing an optimal environment for operators to work.



AAVM (Advanced Around View Monitoring) Camera System (Option)

The HX Series has a state-of-the-art AAVM video camera system to secure field of vision for operators in all directions, thereby preventing accidents. Operators can easily check the workplace in the front, rear and to the right and left.



* AAVM (Advanced Around View Monitoring): Secure field of vision in all directions by nine views including 3D bird's eye view and 2D/4CH view.

* IMOD (Intelligent Moving Object Detection): Inform when people or dangerous objects are detected within the range of operation (recognition distance: 5 m).

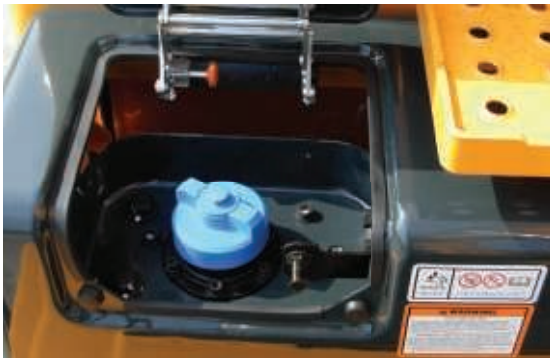

Easy Access to DEF/AdBlue® Supply System

The DEF/AdBlue® tank is installed inside the tool box and its inlet is remotely located for easy access and convenient supply. Warning of overfill is given by a red lamp signal. The DEF/AdBlue® supply module is attached on the side of the fuel tank for easy maintenance and filter replacement.



Hi-mate (Remote Management System)

Hi-mate, Hyundai's proprietary remote management system, provides operators and dealer service personnel access to vital service and diagnostic information on the machine from any computer with internet access. Users can pinpoint machine location using digital mapping and set machine work boundaries, reducing the need for multiple service calls. Hi-mate saves time and money for the owner and dealer by promoting preventative maintenance and reducing machine downtime.

* Operation of the system may be affected by the condition of telecommunication signal



*Photo may include optional equipment.

Cab Suspension Mount

With a low-vibration design by the coil spring and damper inside the mount, the cab suspension mount of the HX Series reduces noise inside the cabin and improves durability, providing a comfortable operation space that lessens operators' fatigue.

Forced Swing Parking (Option)

Forced swing parking is provided to maintain stability when swing movement needs to be limited, improving operating speed and productivity.

SPECIFICATIONS

ENGINE			
Maker / Model		Cummins QSL9	
Type		Water cooled, 4 cycle Diesel, 6-cylinders in line, Direct injection, Turbocharged, Charger air cooled, Low emission	
Rated flywheel horse power	SAE	J1995 (gross)	277 kW (372 HP) at 1,800 rpm
		J1349 (net)	267 kW (358 HP) at 1,800 rpm
	DIN	6271/1 (gross)	277 kW (377 PS) at 1,800 rpm
		6271/1 (net)	267 kW (363 PS) at 1,800 rpm
Max. torque		166 kgf-m (1,186 lbf-ft) at 1,500 rpm	
Bore x stroke		114 x 145 mm (4.5" x 5.7")	
Piston displacement		8,900 cc (543 cu in)	
Batteries		2 x 12 V x 160 Ah	
Starting motor		24 V - 7.8 kW	
Alternator		24 V - 95 A	

HYDRAULIC SYSTEM	
MAIN PUMP	
Type	Variable displacement tandem axis piston pumps
Max. flow	2 x 333 ℓ/min (88.0 U.S. gpm / 73.2 U.K. gpm)
Sub-pump for pilot circuit	Gear pump

Cross-sensing and fuel saving pump system

HYDRAULIC MOTORS	
Travel	Two speed axial pistons motor with brake valve and parking brake
Swing	Axial piston motor with automatic brake

RELIEF VALVE SETTING	
Implement circuits	330 kgf/cm ² (4,690 psi)
Travel	360 kgf/cm ² (5,120 psi)
Power boost (boom, arm, bucket)	360 kgf/cm ² (5,120 psi)
Swing circuit	290 kgf/cm ² (4,125 psi)
Pilot circuit	40 kgf/cm ² (569 psi)
Service valve	Installed

HYDRAULIC CYLINDERS	
No. of cylinder bore x stroke	Boom: Ø 2-160 x 1,500 mm (6.3" x 59.1")
	Arm: Ø 1-170 x 1,760 mm (6.7" x 69.3")
	Bucket: Ø 1-150 x 1,295 mm (5.9" x 51.0")

DRIVES & BRAKES	
Drive method	Fully hydrostatic type
Drive motor	Axial piston motor, in-shoe design
Reduction system	Planetary reduction gear
Max. drawbar pull	33,500 kgf (73,854 lbf)
Max. travel speed (high / low)	5.3 km/hr (3.3 mph) / 3.0 km/hr (1.9 mph)
Gradeability	35° (70%)
Parking brake	Multi wet disc

CONTROL	
Pilot pressure operated joysticks and pedals with detachable lever provide almost effortless and fatigueless operation.	
Pilot control	Two joysticks with one safety lever (LH): Swing and arm (RH): Boom and bucket (ISO)
Traveling and steering	Two levers with pedals
Engine throttle	Electric, Dial type

SWING SYSTEM	
Swing motor	Fixed displacement axial piston motor
Swing reduction	Planetary gear reduction
Swing bearing lubrication	Grease-bathed
Swing brake	Multi wet disc
Swing speed	9.2 rpm

SERVICE REFILL CAPACITIES			
Re-filling	Liter	US gal	UK gal
Fuel tank	600	159	132
Engine coolant	55	14.5	12.1
Engine oil	30	7.9	6.6
Swing device (each)	8	2.1	1.8
Final drive (each)	12	3.2	2.6
Hydraulic system (including tank)	414	109.7	91.1
Hydraulic tank	210	55.5	41.8

UNDERCARRIAGE	
The X-leg type center frame is integrally welded with reinforced box-section track frames. The undercarriage includes lubricated rollers, idlers, track adjusters with shock absorbing springs and sprockets and a track chain with double or triple grouser shoes.	
Center frame	X - leg type
Track frame	Pentagonal box type
No. of shoes on each side	53 EA
No. of carrier roller on each side	2 EA
No. of track roller on each side	9 EA
No. of rail guard on each side	2 EA

OPERATING WEIGHT (APPROXIMATE)	
Operating weight, including 6,500 mm (21' 4") boom, 3,200 mm (10' 6") arm, SAE heaped 1.9 m ³ (2.49 yd ³) Rock bucket, lubricant, coolant, full fuel tank, full hydraulic tank, and all standard equipments.	

OPERATING WEIGHT			
Shoes	Width	Operating weight	Ground pressure
Type	mm (in)	kg (lb)	kgf/cm ² (psi)
Triple grouser	600 (24")	44,120 (97,270)	0.76 (10.81)
	700 (28")	44,640 (98,410)	0.66 (9.39)
	750 (30")	44,900 (98,990)	0.62 (8.82)
	800 (32")	45,170 (99,580)	0.59 (8.39)
	900 (36")	45,680 (100,710)	0.53 (7.54)
Triple grouser (Heavy duty)	600 (24")	44,300 (97,660)	0.77 (10.95)
	700 (28")	44,850 (98,880)	0.67 (9.53)
Double grouser	600 (24")	43,930 (96,850)	0.76 (10.81)
	700 (28")	44,050 (97,110)	0.60 (9.39)

BUCKET SELECTION GUIDE & DIGGING FORCE

BUCKETS

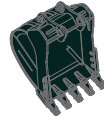

SAE heaped
m³ (yd³)

- ◆ 1.90 (2.49)
- ◆ 2.10 (2.75)

Capacity m ³ (yd ³)		Width mm (in)	Weight kg (lb)	Recommendation mm (ft.in)	
SAE heaped	CECE heaped			6,500 (21' 4") Boom	
				2,600 (8' 6") Arm	3,200 (10' 6") Arm
◆ 1.90 (2.49)	1.65 (2.16)	1,665 (66")	1,980 (4,370)	●	⊙
◆ 2.10 (2.75)	1.84 (2.41)	1,800 (71")	2,080 (4,590)	⊙	○

◆ Rock-Heavy duty bucket

- : Applicable for materials with density of 2,000 kg /m³ (3,370 lb/ yd³) or less
- ⊙ : Applicable for materials with density of 1,600 kg /m³ (2,700 lb/ yd³) or less
- : Applicable for materials with density of 1,100 kg /m³ (1,850 lb/ yd³) or less

ATTACHMENT

Booms and arms are welded with a low-stress, full-box section design.
6.5 m & 10.2 m Booms and 2.1 m; 2.5 m; 3.05 m; 3.75 m & 7.85 m. Arms are available.

DIGGING FORCE

Arm	Length	mm (ft.in)	2,600 (8' 6")	3,200 (10' 6")	Remarks:
	Weight	kg (lb)	1,990 (4,390)	2,080 (4,590)	
Bucket digging force	SAE	kN	201.0 [219.3]	201.0 [219.3]	[]: Power Boost
		kgf	20,500 [22,360]	20,500 [22,360]	
		lbf	45,190 [49,300]	45,190 [49,300]	
	ISO	kN	228.5 [249.3]	228.5 [249.3]	
		kgf	23,300 [25,420]	23,300 [25,420]	
		lbf	51,370 [56,040]	51,370 [56,040]	
Arm crowd force	SAE	kN	180.7 [197.2]	160.8 [175.4]	
		kgf	18,430 [20,110]	16,400 [17,890]	
		lbf	40,630 [44,330]	36,160 [39,440]	
	ISO	kN	188.0 [205.1]	165.7 [180.8]	
		kgf	19,170 [20,910]	16,900 [18,440]	
		lbf	42,260 [46,100]	37,260 [40,650]	

Note : Boom weight includes arm cylinder, piping, and pin
Arm weight includes bucket cylinder, linkage, and pin

DIMENSIONS & WORKING RANGE

HX430 L DIMENSIONS

6.5 m (21' 4") BOOM and 2.6 m (8' 6"); 3.2 m (10' 6") ARM

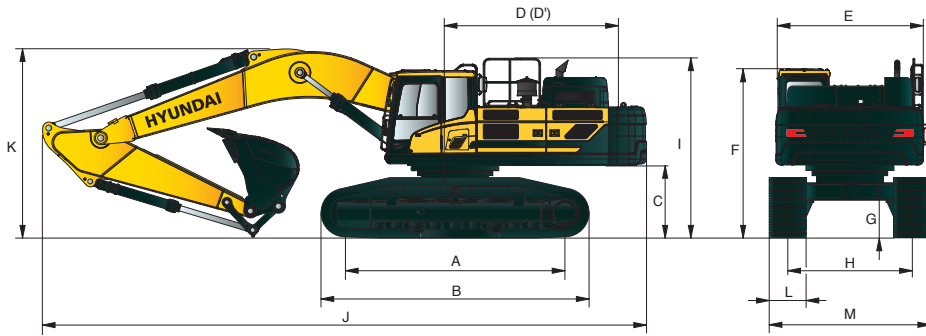

Unit : mm (ft-in)

A	Tumbler distance	4,470 (14' 8")
B	Overall length of crawler	5,462 (17' 11")
C	Ground clearance of counterweight	1,295 (4' 3")
D	Tail swing radius	3,615 (11' 10")
D'	Rear-end length	3,555 (11' 8")
E	Overall width of upperstructure	3,095 (10' 2")
F	Overall height of cab	3,240 (10' 8")
G	Min. ground clearance	565 (1' 10")
H	Track gauge	2,740 (9' 00")
I	Overall height of guardrail	3,445 (11' 4")

Boom length	6,550 (21' 4")				
Arm length	2,600 (8' 6")	3,200 (10' 6")			
J Overall length	11,270 (37' 0")	11,400 (37' 5")			
K Overall height of boom	3,740 (12' 3")	3,630 (11' 11")			
L Track shoe width	600 (24")	700 (28")	750 (30")	800 (32")	900 (36")
M Overall width	3,340 (10' 11")	3,440 (11' 3")	3,490 (11' 5")	3,540 (11' 7")	3,640 (11' 11")

HX430 L WORKING RANGE

Unit : mm (ft-in)

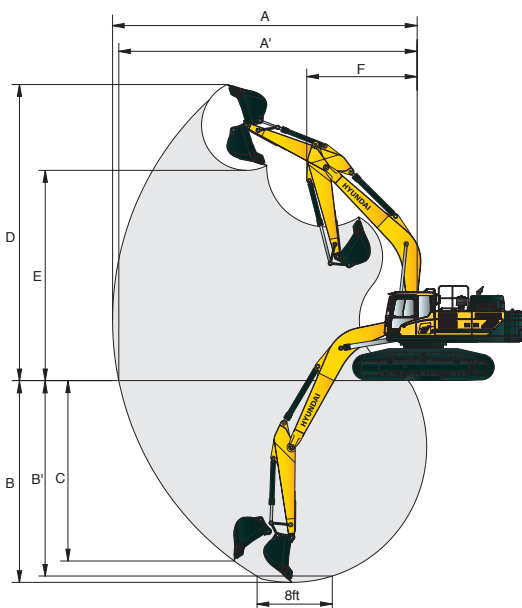











Boom length	6,500 (21' 4")	
Arm length	2,600 (8' 6")	3,200 (10' 6")
A Max. digging reach	10,750 (35' 3")	11,160 (36' 7")
A' Max. digging reach on ground	10,520 (34' 6")	10,930 (35' 10")
B Max. digging depth	6,910 (22' 8")	7,500 (24' 7")
B' Max. digging depth (8ft level)	6,730 (22' 1")	7,350 (24' 1")
C Max. vertical wall digging depth	5,100 (16' 9")	5,440 (17' 10")
D Max. digging height	10,390 (34' 1")	10,290 (33' 9")
E Max. dumping height	7,250 (23' 9")	7,200 (23' 7")
F Min. swing radius	4,540 (14' 11")	4,490 (14' 9")

LIFTING CAPACITY















 Rating over-front  Rating over-side or 360 degrees

HX430 L

6.5 m (21' 4") boom; 2.6 m (8' 6") arm equipped with 2.10 m³ (SAE heaped) bucket and 600 mm (24") triple grouser shoes.

Load point height m (ft)		Load radius								At max. reach		
		3.0 m (10 ft)		4.5 m (15 ft)		6.0 m (20 ft)		7.5 m (25 ft)		Capacity		Reach m (ft)
												
9.0 m (30 ft)	kg									*6110	*6110	6.70
	lb									*13470	*13470	(22.0)
7.5 m (25 ft)	kg									*6020	*6020	8.02
	lb									*13270	*13270	(26.3)
6.0 m (20 ft)	kg					*7120	*7120	*6600	*6600	*6110	5360	8.86
	lb					*15700	*15700	*14550	*14550	*13470	11820	(29.1)
4.5 m (15 ft)	kg			*11000	*11000	*8440	*8440	*7210	*7210	*6270	4660	9.37
	lb			*24250	*24250	*18610	*18610	*15900	*15900	*13820	10270	(30.7)
3.0 m (10 ft)	kg			*14280	*14280	*10020	*10020	*8020	7050	*6500	4310	9.59
	lb			*31480	*31480	*22090	*22090	*17680	15540	*14330	9500	(31.5)
1.5 m (5 ft)	kg			*16530	15120	*11380	9660	*8800	6730	*6770	4240	9.56
	lb			*36440	33330	*25090	21300	*19400	14840	*14930	9350	(31.4)
Ground Line	kg			*17270	14740	*12190	9310	*9320	6510	*7070	4450	9.27
	lb			*38070	32500	*26870	20530	*20550	14350	*15590	9810	(30.4)
-1.5 m (-5 ft)	kg	*18230	*18230	*16960	14720	*12320	9190	*9370	6430	*7360	5020	8.68
	lb	*40190	*40190	*37390	32450	*27160	20260	*20660	14180	*16230	11070	(28.5)
-3.0 m (-10 ft)	kg	*21990	*21990	*15720	14940	*11590	9290			*7530	6250	7.73
	lb	*48480	*48480	*34660	32940	*25550	20480			*16600	13780	(25.4)
-4.5 m (-15 ft)	kg	*17990	*17990	*13070	*13070					*7190	*7190	6.24
	lb	*39660	*39660	*28810	*28810					*15850	*15850	(20.5)

6.5 m (21' 4") boom; 3.2 m (10' 6") arm equipped with 1.90 m³ (SAE heaped) bucket and 600 mm (24") triple grouser shoes.

Load point height m (ft)		Load radius						At max. reach								
		1.5 m (5 ft)		3.0 m (10 ft)		4.5 m (15 ft)		6.0 m (20 ft)		7.5 m (25 ft)		9.0 m (30 ft)		Capacity		Reach m (ft)
																
9.0 m (30 ft)	kg												*5440	*5440	7.31	
	lb												*11990	*11990	(24.0)	
7.5 m (25 ft)	kg												*5490	*5490	8.53	
	lb												*12100	*12100	(28.0)	
6.0 m (20 ft)	kg												*6000	*6000	9.32	
	lb												*13230	*13230	(30.6)	
4.5 m (15 ft)	kg							*7670	*7670	*6690	*6690	*5290	*5290	*5850	4450	9.80
	lb							*16910	*16910	*14750	*14750	*11660	*11660	*12900	9810	(32.2)
3.0 m (10 ft)	kg					*12950	*12950	*9350	*9350	*7600	7290	*6650	5220	*6110	4130	10.01
	lb					*28550	*28550	*20610	*20610	*16760	16070	*14660	11510	*13470	9110	(32.8)
1.5 m (5 ft)	kg					*15710	15610	*10910	9940	*8500	6920	*7140	5020	*6420	4040	9.98
	lb					*34630	34410	*24050	21910	*18740	15260	*15740	11070	*14150	8910	(32.7)
Ground Line	kg			*12890	*12890	*17110	14960	*11990	9480	*9200	6640	*7490	4880	*6770	4190	9.70
	lb			*28420	*28420	*37720	32980	*26430	20900	*20280	14640	*16510	10760	*14930	9240	(31.8)
-1.5 m (-5 ft)	kg	*13760	*13760	*17830	*17830	*17340	14770	12430	9270	*9490	6490			*7150	4640	9.15
	lb	*30340	*30340	*39310	*39310	*38230	32560	*27400	20440	*20920	14310			*15760	10230	(30.0)
-3.0 m (-10 ft)	kg	*18570	*18570	*23870	*23870	*16570	14860	*12110	9270	*9150	6510			*7520	5610	8.26
	lb	*40940	*40940	*52620	*52620	*36530	32760	*26700	20440	*20170	14350			*16580	12370	(27.1)
-4.5 m (-15 ft)	kg	*24270	*24270	*20790	*20790	*14620	*14620	*10670	9500					*7700	*7700	6.89
	lb	*53510	*53510	*45830	*45830	*32230	*32230	*23520	20940					*16980	*16980	(22.6)

- Lifting capacity are based on SAE J1097 and ISO 10567.
- Lifting capacity of the ROBEX series does not exceed 75% of tipping load with the machine on firm, level ground or 87% of full hydraulic capacity.
- The load point is a hook located on the back of the bucket.
- (*) indicates load limited by hydraulic capacity.

ENGINE	STD	OPT
Cummins QSL 9 engine	●	
HYDRAULIC SYSTEM		
Intelligent Power Control (IPC)		
3-power mode, 2-work mode, user mode	●	
Variable Power Control	●	
Pump Flow Control	●	
Attachment Mode Flow Control		●
Engine Auto Idle	●	
Engine Auto Shutdown Control		●
Electronic Fan Control	●	
CABIN & INTERIOR		
ISO Standard cabin		
Rise-up type windshield wiper	●	
Radio / USB player	●	
Handsfree mobile phone system with USB	●	
12 volt power outlet (24V DC to 12V DC converter)	●	
Electric horn	●	
All-weather steel cab with 360° visibility	●	
Safety glass windows	●	
Sliding fold-in front window	●	
Sliding side window (LH)	●	
Lockable door	●	
Hot & cool box	●	
Storage compartment & Ashtray	●	
Transparent cabin roof-cover	●	
Sun visor	●	
Door and cab locks, one key	●	
Mechanical suspension seat with heater	●	
Pilot-operated slidable joystick	●	
Console box height adjust system	●	
Automatic climate control		
Air conditioner & heater	●	
Defroster	●	
Starting Aid (air grid heater) for cold weather	●	
Centralized monitoring		
8" LCD display	●	
Engine speed or Trip meter/Accel.	●	
Engine coolant temperature gauge	●	
Max power	●	
Low speed/High speed	●	
Auto idle	●	
Overload	●	
Check Engine	●	
Air cleaner clogging	●	
Indicators	●	
ECO Gauges	●	
Fuel level gauge	●	
Hyd. oil temperature gauge	●	
Fuel warmer	●	
Warnings	●	
Communication error	●	
Low battery	●	
Clock	●	
Cabin lights		●
Cabin front window rain guard		●
Cabin roof-steel cover		●
Seat		
Adjustable air suspension seat with heater		●
Cabin FOPS/FOG		
FOPS (Falling Object Protective Structure) · ISO 3449 Level 2		●
FOG (Falling Object Guard) · Front & Top Guard		●
ISO/DIS 10262 Level 2 · Top Guard		●
Cabin ROPS (ISO 12117-2)		
ROPS (Roll Over Protective Structure) · ISO 12117-2	●	

SAFETY	STD	OPT
Battery master switch	●	
Rearview camera	●	
AAVM (Advanced Around View Monitoring)		●
Six front working lights	●	
Travel alarm		●
Rear work lamp		●
Beacon lamp		●
Automatic swing brake	●	
Boom holding system	●	
Arm holding system	●	
Safety lock valve for boom cylinder with overload warning device	●	
Safety lock valve for arm cylinder		●
Swing Lock System		●
Three outside rearview mirrors	●	
OTHER		
Booms		
6.5 m; 21' 4"	●	
Arms		
2.6 m; 8' 6"		●
3.2 m; 10' 6"	●	
Removable clean-out dust net for cooler	●	
Removable reservoir tank	●	
Fuel pre-filter with single warmer	●	
Fuel pre-filter with dual warmer		●
Self-diagnostics system	●	
Hi-mate (Remote Management System)	Mobile	●
	Satellite	●
Batteries (2 × 12 V × 160 Ah)	●	
Fuel filler pump (50 l/min)		●
Single-acting piping kit (breaker, etc.)		●
Double-acting piping kit (clamshell, etc.)		●
Rotating Piping Kit		●
Quick coupler piping		●
Quick coupler		●
Boom floating control		●
One Pedal Straight Travel System		●
Accumulator for lowering work equipment	●	
Pattern change valve (2 patterns)		●
Tool kit		●
UNDERCARRIAGE		
Lower frame under cover (Additional)		●
Lower frame under cover (Normal)	●	
Track shoes		
Triple grouser shoes (600 mm; 24")	●	
Triple grouser shoes (700 mm; 28")		●
Triple grouser shoes (750 mm; 30")		●
Triple grousers shoe (800 mm; 32")		●
Triple grousers shoe (900 mm; 36")		●
Triple grousers shoes (600 mm; 24" - Heavy Duty)		●
Triple grousers shoes (700 mm; 28" - Heavy Duty)		●
Double grousers shoe (600 mm; 24")		●
Double grousers shoe (700 mm; 28")		●
Track rail guard	●	
Full track rail guard high walker		●

STD = Standard
OPT = Optional

- * Standard and optional equipment may vary. Contact your Hyundai dealer for more information.
- * The machine may vary according to International standards.
- * The photos may include attachments and optional equipment that are not available in your area.
- * Materials and specifications are subject to change without advance notice.
- * All imperial measurements rounded off to the nearest pound or inch.