

We build a better future

Robex
55-9

Equipped with Tier IIIa Engine



*Photo may include optional equipment.

Pleasure works

An operator, who takes pleasure in his work, does a better job. That is why we at Hyundai Heavy Industries do everything we can to make that happen. We merged operator preference, fast precision and lasting performance into a quality product. Hyundai 9 Series earthmoving equipment simply makes time fly, makes pleasure work!



*Photo may include optional equipment.

Machine Walk-Around

Robust Upper and Lower Frame

The structure of the upper frame is designed to absorb high stress and to resist inherent external influences. An X-type center frame and a reinforced box section track frame provide exceptional strength and longer service life to withstand tough working conditions.

Engine Technology

Powerful and reliable, Tier 3a certified, fuel efficient Yanmar 4TNV98 engine.
Electronically controlled, clean and efficient combustion.
Low noise / anti-restart function.

Control System

Control devices are well located for increased operator's comfort and a higher productivity. The operator can easily control the machine in any working condition. A safety lever on the left side console is installed to prevent exiting the cabin with active hydraulic control levers.

Advanced Hydraulic System

Our new R55-9 is equipped with arm flow summation system, boom holding system and swing parking brake for smooth and fine control. Other integrated features are hydraulic damper in travel pedals, swing reducer lubrication by hydraulic oil and leak-free grease chamber of swing bearing.

Comfortable and High-Strength Cabin

The spacious cabin is ergonomically designed, with low noise level and high visibility. Canopy & cabin frame are complying with international standard TOPS, ROPS & FOPS, for maximum protection of the operator.

Operators' Convenience

R55-9 cabin equipped with suspension seat, foldable pedals and various storage space for advanced operator comfort. The newly designed LED-cluster displays engine RPM, engine temperature, fuel level and state of electric devices to check the full status of the machine at a single glance. Diagnostic functions are also integrated. Powerful air conditioning and radio with MP3-player makes a Hyundai excavator a pleasure to operate.

Easy to Maintain

With open access of doors, covers and engine hoods, air cleaner and centralized grease fittings the machine is a pleasure to maintain.

Extended Life of Components

Long-life hydraulic filters, long-life hydraulic oil, long-lasting shims and long-lasting bushes are reducing operation costs.

Preference

An operator, who sets his machine to his needs, takes pleasure in his work. Our R55-9 respects operator preference with regards to comfort, ease-of-use and controllability. Operators can fully customize their work environment and operating preferences to fit their individual needs.



*Photo may include optional equipment.



Spacious Cabin with Excellent Visibility

The spacious cabin is ergonomically designed with low noise levels and high visibility. Special attention was paid to create a clear, open and convenient interior with excellent visibility in all directions. This well balanced operators' environment put the operator in the perfect position to work safely and securely.

Operator Comfort

In the cabin of our R55-9 you can experience the highest level of comfort. The ergonomic location of joysticks with arm rests, suspension seat, control levers and LED-display minimizes fatigue of the operator. The LED-display shows all information of the machine with a blink of an eye.

1. A large top glass combined with a roll-up sun visor offers high visibility.
2. An advanced audio system with radio / MP3-player with AUX-input, combined with a remote control is installed to listen to your preferred music favorites.
3. Operators are able to call while operating with the hands-free mobile phone feature.
4. Ergonomically designed joysticks reduce operator fatigue.
5. Cabin provides various storage compartments for operator's convenience.



Roll-up Sun visor Radio / MP3-player with remote control Hands-free cell phone Ergonomic joysticks Storage compartments

Stressless

Work is stressful enough; your working environment should be stressless. Hyundai's R55-9 compact excavator provides many convenient devices for safe and productive work.

1. The window locking device keeps the right window in the preferred position.
2. The sliding front window is easy to open and can be locked safely in open position to improve ventilation and visibility.
3. The tiltable left-side console box offers easy access to the cabin.
4. The powerful temperature control provides the operator with the preferred air temperature.



Window locking device

Sliding front window

Tilttable console box

Climate control system



Easy-to-use Cluster

The advanced LED-cluster allows the operator to select his personal machine preferences. The monitor displays engine rpm, engine temperature and state of electronic devices. The operator can select auto deceleration mode and max power mode and he can control travel speed with the touch of a button. An engine starting lock prevents theft of the machine.

Precision & Performance

An operator, who feels his machine respond smoothly, takes pleasure in his work. 9 Series deliver fast precision by combining smoother hydraulics with wider view and less stress. Innovative hydraulic system technologies make the R55-9 excavator fast, smooth and easy to control.



*Photo may include optional equipment.

Excellent Performance

Hyundai's 9 series offer maximum productivity and high efficiency. With the engine dial, the operator can adjust the engine power to the specific application. A max power button maximizes machine speed and power for maximum productivity. R55-9 features auto deceleration to reduce fuel consumption and cabin noise level.

Improved Hydraulic System



To achieve optimum precision, Hyundai redesigned the hydraulic system to provide the operator with super fine touch and high controllability. Improved pump flow control reduces hydraulic flow when controls are not activated to minimize fuel consumption. Improved spool valves in the main control valve are engineered to provide more precise flow to each function with less effort. Improved hydraulic valves, precise variable volume piston pumps, fine-touch pilot controls and enhanced travel functions make any operator of our 9 series look like a smooth operator. Additional features include boom regeneration and new control valve technology for optimal performance in any application.

Offset Boom

The R55-9's boom offset function is designed for efficient work in congested residential and urban areas. The boom can be offset from 80° to the left up to 50° to the right. Increased swing torque provides better operating capability on a slope.

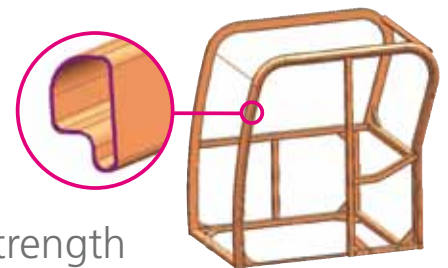

Structural Strength

The 9 Series cabin structure is designed with slimmer but stronger tubing for more safety and better visibility. Low-stress and high strength steel is welded to form a strong and stable lower frame. Structural durability is analyzed and tested by FEM-analysis (Finite Elements Method) and long-term durability tests.



Yanmar 4TNV98

Yanmar 4TNV98 engine provides a nominal power of 57 HP at 2.400 rpm. This means the R55-9 runs with the most power in its class, giving you more power to get the job done.

Profitable

An owner, who knows his machine saves money, takes pleasure in owning it. 9 Series excavators contribute to your business as a time, fuel, spare-part and cost saving earthmoving solution.



*Photo may include optional equipment.

Fuel Efficient

9 series compact excavators are engineered to be very fuel efficient. A cooling fan with viscous fan clutch will reduce fuel consumption and will reduce the noise level in the cabin.

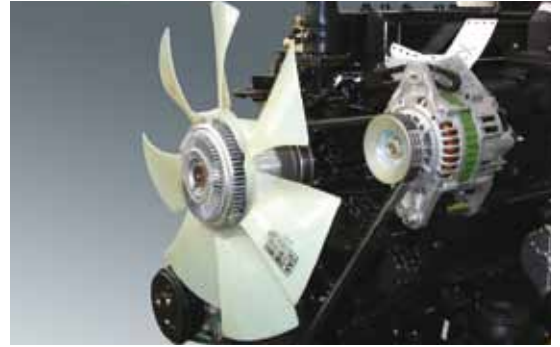

Improved Durability

The R55-9 is equipped with side protection of the counterweight to protect the engine hood. A cover of the dozer cylinder provides extra protection in tough working conditions.



Easy Maintenance

Centralized grease fittings and easy to change air filter provide faster and easier maintenance.

Large Engine hood

9 series compact excavator are offering easy access to the engine compartment with a large engine hood.



Extended Life of Components

By adopting long-life hydraulic filters (1000 hrs) and long-life hydraulic oil (5000 hrs) operation costs are reduced. Extended lubricant bush life & ultra high molecular weight polymer shim, more efficient cooling systems and integrated preheating systems are extending service intervals and reducing machine down time.

Specifications

ENGINE

MODEL	YANMAR 4TNV98		
Type	Water cooled, 4 cycle Diesel, 4-Cylinders in line, direct injection and low emission		
Rated flywheel horse power	SAE	J1995 (gross)	57 HP (42.5 kW) at 2,400 rpm
		J1349 (net)	55.2 HP (41.2 kW) at 2,400 rpm
	DIN	6271/1 (gross)	57.8 PS (42.5 kW) at 2,400 rpm
		6271/1 (net)	56 PS (41.2 kW) at 2,400 rpm
Max. torque	20.5 kgf.m (148 lbf.ft) at 1,550 rpm		
Bore x stroke	98 mm (3.86") x 110 mm (4.33")		
Piston displacement	3,319 cc (203 cu in)		
Batteries	1 x 12 V x 100 AH		
Starting motor	12 V - 3.0 kW		
Alternator	12 V - 80 Amp		

HYDRAULIC SYSTEM

MAIN PUMP	
Type	Two variable displacement piston pumps
Max. flow	2 x 55 ℓ/min (14.5 US gpm / 12 UK gpm)
Sub-pump for pilot circuit	Gear pump
Cross-sensing and fuel saving pump system	

HYDRAULIC MOTORS	
Travel	Two speed axial piston motor with brake valve and parking brake
Swing	Axial piston motor with automatic brake

RELIEF VALVE SETTING	
Implement circuits	220 kgf/cm ² (3,130 psi)
Travel	220 kgf/cm ² (3,130 psi)
Swing circuit	220 kgf/cm ² (3,130 psi)
Pilot circuit	30 kgf/cm ² (430 psi)
Service valve	Installed

HYDRAULIC CYLINDERS	
No. of cylinder-bore x rod x stroke	Boom: 1 - 110 x 60 x 715 mm (4.3"x 2.4"x 28.1")
	Arm: 1 - 90 x 55 x 850 mm (3.5"x 2.2"x 33.5")
	Bucket: 1 - 80 x 50 x 660 mm (3.1"x 2.0"x 26.0")
	Boom swing: 1 - 95 x 50 x 527 mm (3.7"x 2.0"x 20.7")
	Dozer blade: 1 - 110 x 60 x 224 mm (4.3"x 2.4"x 8.4")

DRIVES & BRAKES

Drive method	Fully hydrostatic type
Drive motor	Axial piston motor, in-shoe design
Reduction system	Planetary reduction gear
Max. drawbar pull	5,300 kgf (11,700 lbf)
Max. travel speed (high) / (low)	4.0 km/hr (2.5 mph) / 2.2 km/hr (1.4 mph)
Gradeability	35° (70%)
Parking brake	Multi wet disc

CONTROL

Pilot pressure operated joysticks and pedals with detachable lever provide almost effortless and fatigueless operation.

Pilot control	Two joysticks with one safety lever (LH): Arm and swing (RH): Boom and bucket (ISO)
Traveling and steering	Two levers with pedals
Engine throttle	Electric, Dial type
Lights	Two lights mounted on the boom, one light mounted under the battery box one light mounted under the cabin

SWING SYSTEM

Swing motor	Axial piston motor
Swing reduction	Planetary gear reduction
Swing bearing lubrication	Grease-bathed
Swing brake	Multi wet disc
Swing speed	9.3 rpm

COOLANT & LUBRICANT CAPACITY

Refilling	liter	US gal	UK gal
Fuel tank	125	33.0	27.5
Engine coolant	9.5	2.5	2.1
Engine oil	11.6	3.1	2.6
Swing device - gear oil	1.5	0.4	0.3
Final drive (each)	1.2	0.3	0.3
Hydraulic tank	70.0	18.5	15.4
Hydraulic system (including tank)	120.0	31.7	26.4

UNDERCARRIAGE

The X-leg type center frame is integrally welded with reinforced box-section track frames. The undercarriage includes lubricated rollers, idlers, track adjusters with shock absorbing springs and sprockets, and a track chain with double or triple grouser shoes.

Center frame	X - leg type
Track frame	Pentagonal box type
No. of shoes on each side	40
No. of carrier rollers on each side	1
No. of track rollers on each side	5

OPERATING WEIGHT (APPROXIMATE)

Operating weight, including 3,000 mm (9' 10") boom; 1,600 mm (5' 3") arm, SAE heaped 0.18 m³ (0.24 yd³) bucket, lubricant, coolant, full fuel tank, full hydraulic tank, and all standard equipments.

MAJOR COMPONENT WEIGHT	
Upperstructure	2,710 kg (5,970 lb)
Counterweight	230 kg (510 lb)
Mono boom (with arm cylinder)	310 kg (680 lb)

OPERATING WEIGHT	
Operating weight	5,650 kg (12,460 lb)

- Mono boom with blade

BUCKETS

Capacity		Width		Weight
SAE heaped	CECE heaped	Without side cutters	With side cutters	
0.07 m ³ (0.09 yd ³)	0.06 m ³ (0.08 yd ³)	315 mm (12.4")	360 mm (14.2")	115 kg (255 lb)
0.18 m ³ (0.24 yd ³)	0.15 m ³ (0.20 yd ³)	670 mm (26.4")	740 mm (29.1")	170 kg (375 lb)

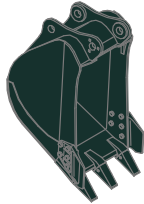

SAE heaped m³ (yd³)

0.07 m³ (0.09 yd³)

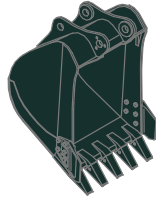

0.18 m³ (0.24 yd³)

DIGGING FORCE

Arm	Length	1,600 mm (5' 3")	1,900 mm (6' 3")
	Weight	210 kg (460 lb)	230 kg (510 lb)
Bucket digging force	SAE	37.7 kN	37.7 kN
		3,850 kgf	3,850 kgf
		8,490 lbf	8,490 lbf
	ISO	42.4 kN	42.4 kN
		4,330 kgf	4,330 kgf
		9,550 lbf	9,550 lbf
Arm crowd force	SAE	28.4 kN	25.5 kN
		2,900 kgf	2,600 kgf
		6,390 lbf	5,730 lbf
	ISO	31.9 kN	28.7 kN
		3,260 kgf	2,930 kgf
		7,190 lbf	6,460 lbf

* Arm weight includes bucket cylinder and bucket linkage.

Lifting Capacities

R55-9

Rating over-front Rating over-side or 360 degrees

Boom : 3.0 m (9' 10") / Arm : 1.6 m (5' 3") / Bucket : 0.18 m³ (0.24 yd³) SAE heaped / Dozer blade down with 230 kg (510 lb) counterweight.

Load point height m (ft)	Load radius								At max. reach			
	2.0 m (7 ft)		3.0 m (10 ft)		4.0 m (13 ft)		5.0 m (16 ft)		Capacity		Reach m (ft)	
5.0 m (16 ft)	kg									*950	*950	4.12
	lb									*2090	*2090	(13.5)
4.0 m (13 ft)	kg					*1020	*1020			*980	780	5.08
	lb					*2250	*2250			*2160	1720	(16.7)
3.0 m (10 ft)	kg					*1090	*1090			*1010	650	5.60
	lb					*2400	*2400			*2230	1430	(18.4)
2.0 m (7 ft)	kg	*3050	*3050	*1690	*1690	*1320	1100	*1170	760	*1050	590	5.84
	lb	*6720	*6720	*3730	*3730	*2910	2430	*2580	1680	*2310	1300	(19.2)
1.0 m (3 ft)	kg			*2360	1610	*1600	1040	*1280	740	*1100	580	5.85
	lb			*5200	3550	*3530	2290	*2820	1630	*2430	1280	(19.2)
Ground Line	kg	*2350	*2350	*2700	1540	*1790	1000	*1350	720	*1140	610	5.63
	lb	*5180	*5180	*5950	3400	*3950	2200	*2980	1590	*2510	1340	(18.5)
-1.0 m (-3 ft)	kg	*3600	3020	*2670	1530	*1800	990			*1180	700	5.13
	lb	*7940	6660	*5890	3370	*3970	2180			*2600	1540	(16.8)
-2.0 m (-7 ft)	kg	*3770	3060	*2300	1540					*1140	960	4.23
	lb	*8310	6750	*5070	3400					*2510	2120	(13.9)
-3.0 m (-10 ft)	kg	*2040	*2040									
	lb	*4500	*4500									











- Lifting capacity is based on SAE J1097, ISO 10567.
- Lifting capacity of the Robex Series does not exceed 75% of the tipping load with the machine on firm, level ground or 87% of full hydraulic capacity.
- The load point is a hook located on the back of the bucket.
- (*) indicates the load limited by hydraulic capacity.

Lifting Capacities











R55-9

 Rating over-front  Rating over-side or 360 degrees











Boom : 3.0 m (9' 10") / Arm : 1.6 m (5' 3") / Bucket : 0.18 m³ (0.24 yd³) SAE heaped / Dozer blade up with 230 kg (510 lb) counterweight.

Load point height m (ft)		Load radius								At max. reach		
		2.0 m (7 ft)		3.0 m (10 ft)		4.0 m (13 ft)		5.0 m (16 ft)		Capacity		Reach m (ft)
												
5.0 m (16 ft)	kg									*950	*950	4.12
	lb									*2090	*2090	(13.5)
4.0 m (13 ft)	kg					*1020	*1020			*980	740	5.08
	lb					*2250	*2250			*2160	1630	(16.7)
3.0 m (10 ft)	kg					*1090	1080			890	610	5.60
	lb					*2400	2380			1960	1340	(18.4)
2.0 m (7 ft)	kg	*3050	*3050	*1690	1630	*1320	1030	1040	710	810	550	5.84
	lb	*6720	*6720	*3730	3590	*2910	2270	2290	1570	1790	1210	(19.2)
1.0 m (3 ft)	kg			2250	1510	1430	980	1010	690	800	540	5.85
	lb			4960	3330	3150	2160	2230	1520	1760	1190	(19.2)
Ground Line	kg	*2350	*2350	2170	1440	1390	940	990	670	840	570	5.63
	lb	*5180	*5180	4780	3170	3060	2070	2180	1480	1850	1260	(18.5)
-1.0 m (-3 ft)	kg	*3600	2780	2150	1420	1370	930			970	660	5.13
	lb	*7940	6130	4740	3130	3020	2050			2140	1460	(16.8)
-2.0 m (-7 ft)	kg	*3770	2830	2170	1440					*1140	900	4.23
	lb	*8310	6240	4780	3170					*2510	1980	(13.9)
-3.0 m (-10 ft)	kg	*2040	*2040									
	lb	*4500	*4500									

Boom : 3.0 m (9' 10") / Arm : 1.9 m (6' 3") / Bucket : 0.18 m³ (0.24 yd³) SAE heaped / Dozer blade down with 230 kg (510 lb) counterweight.

Load point height m (ft)		Load radius								At max. reach		
		2.0 m (7 ft)		3.0 m (10 ft)		4.0 m (13 ft)		5.0 m (16 ft)		Capacity		Reach m (ft)
												
5.0 m (16 ft)	kg									*870	*870	4.58
	lb									*1920	*1920	(15.0)
4.0 m (13 ft)	kg									*900	700	5.43
	lb									*1980	1540	(17.8)
3.0 m (10 ft)	kg					*950	*950	*990	780	*930	590	5.91
	lb					*2090	*2090	*2180	1720	*2050	1300	(19.4)
2.0 m (7 ft)	kg			*1440	*1440	*1190	1110	*1080	760	*970	540	6.13
	lb			*3170	*3170	*2620	2450	*2380	1680	*2140	1190	(20.1)
1.0 m (3 ft)	kg	*2050	*2050	*2160	1630	*1500	1050	*1220	740	*1020	530	6.14
	lb	*4520	*4520	*4760	3590	*3310	2310	*2690	1630	*2250	1170	(20.1)
Ground Line	kg	*2280	*2280	*2610	1540	*1730	1000	*1320	710	*1060	550	5.93
	lb	*5030	*5030	*5750	3400	*3810	2200	*2910	1570	*2340	1210	(19.5)
-1.0 m (-3 ft)	kg	*3230	2980	*2700	1510	*1810	980	*1310	700	*1100	620	5.48
	lb	*7120	6570	*5950	3330	*3990	2160	*2890	1540	*2430	1370	(18.0)
-2.0 m (-7 ft)	kg	*4140	3020	*2450	1520	*1630	980			*1100	810	4.67
	lb	*9130	6660	*5400	3350	*3590	2160			*2430	1790	(15.3)
-3.0 m (-10 ft)	kg	*2760	*2760	*1640	1570							
	lb	*6080	*6080	*3620	3460							

Boom : 3.0 m (9' 10") / Arm : 1.9 m (6' 3") / Bucket : 0.18 m³ (0.24 yd³) SAE heaped / Dozer blade up with 230 kg (510 lb) counterweight.

Load point height m (ft)		Load radius								At max. reach		
		2.0 m (7 ft)		3.0 m (10 ft)		4.0 m (13 ft)		5.0 m (16 ft)		Capacity		Reach m (ft)
												
5.0 m (16 ft)	kg									*870	*870	4.58
	lb									*1920	*1920	(15.0)
4.0 m (13 ft)	kg									*900	660	5.43
	lb									*1980	1460	(17.8)
3.0 m (10 ft)	kg					*950	*950	*990	740	810	550	5.91
	lb					*2090	*2090	*2180	1630	1790	1210	(19.4)
2.0 m (7 ft)	kg			*1440	*1440	*1190	1040	1040	720	750	500	6.13
	lb			*3170	*3170	*2620	2290	2290	1590	1650	1100	(20.1)
1.0 m (3 ft)	kg	*2050	*2050	*2160	1530	1440	980	1010	690	740	490	6.14
	lb	*4520	*4520	*4760	3370	3170	2160	2230	1520	1630	1080	(20.1)
Ground Line	kg	*2280	*2280	2170	1440	1390	940	990	670	770	510	5.93
	lb	*5030	*5030	4780	3170	3060	2070	2180	1480	1700	1120	(19.5)
-1.0 m (-3 ft)	kg	*3230	2740	2140	1410	1360	910	980	660	870	580	5.48
	lb	*7120	6040	4720	3110	3000	2010	2160	1490	1920	1280	(18.0)
-2.0 m (-7 ft)	kg	*4140	2780	2150	1420	1370	920			*1100	760	4.67
	lb	*9130	6130	4740	3130	3020	2030			*2430	1680	(15.3)
-3.0 m (-10 ft)	kg	*2760	*2760	*1640	1470							
	lb	*6080	*6080	*3620	3240							

- Lifting capacity is based on SAE J1097, ISO 10567.
- Lifting capacity of the Robex Series does not exceed 75% of the tipping load with the machine on firm, level ground or 87% of full hydraulic capacity.
- The load point is a hook located on the back of the bucket.
- (*) indicates the load limited by hydraulic capacity.

Dimensions & Working Ranges

DIMENSIONS R55-9

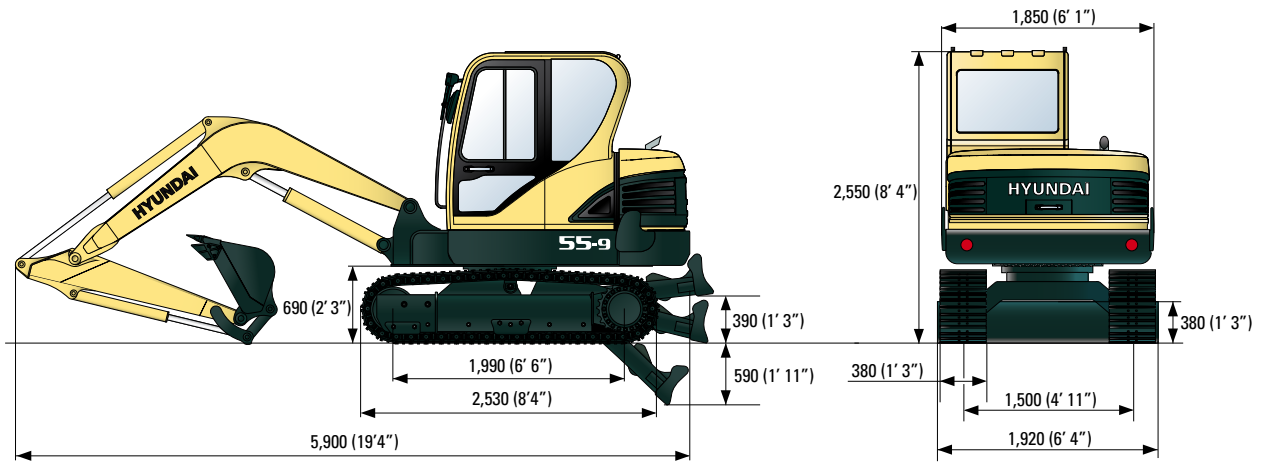

WORKING RANGES R55-9

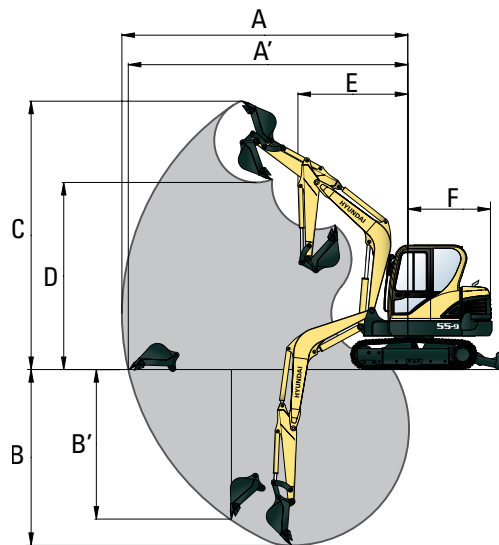

Boom length	3,000 (9' 10")	
Arm length	1,600 (5' 3")	1,900 (6' 3")
A Max. digging reach	6,150 (20' 2")	6,400 (20' 1")
A' Max. digging reach on ground	6,010 (19' 9")	6,270 (20' 7")
B Max. digging depth	3,820 (12' 6")	4,060 (13' 4")
B' Max. vertical wall digging depth	3,200 (10' 6")	3,460 (11' 4")
C Max. cutting height	5,780 (18' 12")	5,920 (19' 5")
D Max. dumping height	4,050 (13' 3")	4,180 (13' 9")
E Min. swing radius	2,350 (7' 9")	2,360 (7' 9")
F Tail swing radius	1,650 (5' 5")	1,650 (5' 5")



Notes

STANDARD EQUIPMENT

ISO standard cabin

- Cabin ROPS (ISO 3471)
FOPS (ISO 3449)
TOPS (ISO 12117)
- All-weather steel cab with all-around visibility
- All windows consist of safety glass
- Rise-up type windshield wiper
- Sliding fold-in front window
- Sliding side window
- Lockable door
- Accessory box & Ash-tray

Centralized monitoring

- Engine speed
- Gauges
 - Fuel level gauge
 - Engine coolant temperature gauge

- Warning
 - Fuel level
 - Engine oil pressure
 - Engine coolant temperature
 - Hyd. oil temperature
 - Low battery
 - Air filter clogging
- Fuel prefilter

Door and cab locks, one key fits all

Radio / MP3-player

Two outside rear view mirrors

Fully adjustable suspension seat with seat belt

Console box tilting system (LH.)

Four front working lights

Electric horn

Battery (1 x 12 V x 100 AH)

Battery master switch

12 volt power supply (DC-DC converter)

Removable clean out screen for radiator

Automatic swing brake

Removable reservoir tank

Water separator, fuel line

Counterweight

Mono boom (3.0 m; 9' 10")

Arm (1.6 m; 5' 3")

Track shoes (380 mm; 15.7")

Track rail guard

Starting aid (Air grid heater) Cold weather

Viscous fan clutch

OPTIONAL EQUIPMENT

Air-conditioner

Fuel filler pump (35 l/min; 9.2 US gpm)

Beacon lamp

Single acting piping kit (breaker, etc)

Double acting piping kit (clamshell, etc)

Accumulator, work equipment lowering

Travel alarm

Quick coupler

Rubber crawler (400 mm; 16")

Narrow bucket (0.07 m³; 0.09 yd³)

Long arm (1.9 m; 6' 3")

Tool kit

Operator suit

Mechanical suspension seat with heater

Additional working lamps

Standard and optional equipment may vary. Contact your Hyundai dealer for more information. The machine may vary according to international standards. All imperial measurements rounded off to the nearest pound or inch.

PLEASE CONTACT

