

We build a better future

Robex

80CR-9

Equipped with Tier 3 Engine



*Photo may include optional equipment.

Pleasure works

An operator, who takes pleasure in his work, does a better job. That is why we at Hyundai Heavy Industries do everything we can to make that happen. We merged operator preference, fast precision and lasting performance into a quality product. Hyundai's 9 series earthmoving equipment simply makes time fly, makes pleasure work!



*Photo may include optional equipment.

Robex 80CR-9

Machine Walk-Around

Robust Upper and Lower Frame

The structure of the upper frame is designed to absorb high stress and to resist inherent external influences. An X-type center frame and a reinforced box section track frame provide exceptional strength and longer service life to withstand tough working conditions.

Engine Technology

Powerful and reliable, Tier 3a certified, fuel efficient Yanmar 4TNV98 engine. Electronically controlled, clean and efficient combustion. Low noise / anti-restart function.

Control System

Control devices are well located for increased operator's comfort and a higher productivity. The operator can easily control the machine in any working condition. A safety lever on the left side console is installed to prevent exiting the cabin with active hydraulic control levers.

Advanced Hydraulic System

Our new R80CR-9 is equipped with arm flow summation system, boom holding system and swing parking brake for smooth and fine control. Other integrated features are hydraulic damper in travel pedals, swing reducer lubrication by hydraulic oil and leak-free grease chamber of swing bearing.

Comfortable and High-Strength Cabin

The spacious cabin is ergonomically designed, with low noise level and high visibility. Cabin frame meets international standard TOPS, ROPS & FOPS, for maximum protection of the operator.

Operators' Convenience

The cabin of the R80CR-9 is equipped with suspension seat, excellent visibility and various storage space for advanced operator comfort. The newly designed LED-cluster displays engine RPM, engine temperature, fuel level and state of electric devices to check the full status of the machine at a single glance. Diagnostic functions are also integrated. Powerful air conditioning and radio with MP3-player makes a Hyundai excavator a pleasure to operate.

Easy to Maintain

With open access of doors, covers and engine hoods, air cleaner and centralized grease fittings the machine is a pleasure to maintain.

Extended Life of Components

Long-life hydraulic filters, long-life hydraulic oil, long-lasting shims and long-lasting bushes are reducing operation costs.



Preference

An operator, who sets his machine to his needs, takes pleasure in his work. Our R80CR-9 respects operator preference with regards to comfort, ease-of-use and controllability. Operators can fully customize their work environment and operating preferences to fit their individual needs.



*Photo may include optional equipment.



Spacious Cabin with Excellent Visibility

The spacious cabin is ergonomically designed with low noise levels and high visibility. Special attention was paid to create a clear, open and convenient interior with excellent visibility in all directions. This well balanced operators' environment put the operator in the perfect position to work safely and securely.

Operator Comfort

In the cabin of our R80CR-9 you can experience the highest level of comfort. The ergonomic location of joysticks with adjustable arm rests, suspension seat, control levers and LED-display minimizes fatigue of the operator. The LED-display shows all information of the machine with a blink of an eye.

1. A large top glass combined with a roll-up sun visor offers high visibility.
2. An advanced audio system with radio / MP3-player with AUX-input, combined with a remote control is installed to listen to your preferred music favorites.
3. Operators are able to call while operating with the hands-free mobile phone feature.
4. Ergonomically designed joysticks reduce operator fatigue.
5. Accel dial with LED lamp
6. Cabin provides various storage compartments for operator's convenience.

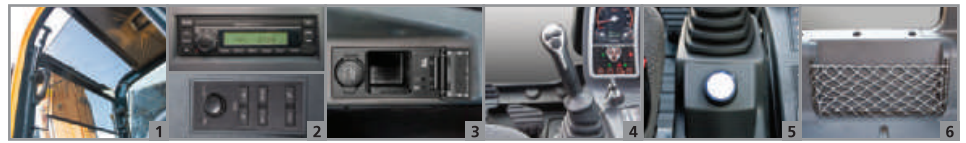

Roll-up Sun visor Radio / MP3-player with remote control Hands-free cell phone Ergonomic joysticks Accel dial with LED lamp Storage compartments

Stressless

Work is stressful enough; your working environment should be stressless. Hyundai's R80CR-9 compact excavator provides many convenient devices for safe and productive work.

1. The window locking device keeps the right window in the preferred position.
2. The sliding front window is easy to open and can be locked safely in open position to improve ventilation and visibility.
3. The tiltable left-side console box offers easy access to the cabin.
4. The automatic temperature control provides the operator with the preferred air temperature.

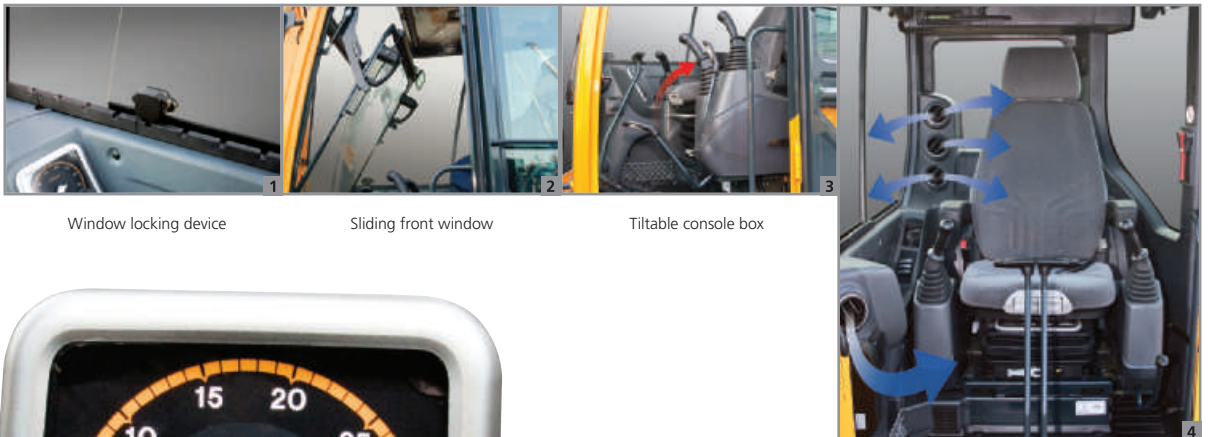

Window locking device

Sliding front window

Tilttable console box

Climate control system



Easy-to-use Cluster

The advanced LED-cluster allows the operator to select his personal machine preferences. The monitor displays engine rpm, engine temperature and state of electronic devices. The operator can select auto deceleration mode and max power mode and he can control travel speed with the touch of a button. An engine starting lock prevents theft of the machine.

Precision & Performance

An operator, who feels his machine respond smoothly, takes pleasure in his work. 9 Series deliver fast precision by combining smoother hydraulics with wider view and less stress. Innovative hydraulic system technologies make the R80CR-9 excavator fast, smooth and easy to control.

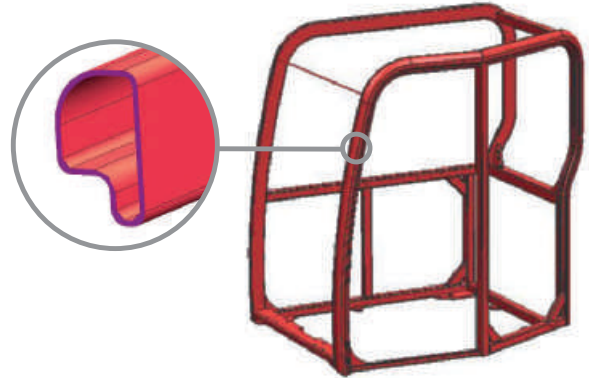

*Photo may include optional equipment.



Offset Boom

The R80CR-9's boom offset function is designed for efficient work in congested residential and urban areas. The boom can be offset from 70° to the left up to 60° to the right. Increased swing torque provides better operating capability on a slope.



Structural Strength

The 9 Series cabin structure is designed with slimmer but stronger tubing for more safety and better visibility. Low-stress and high strength steel is welded to form a strong and stable lower frame. Structural durability is analyzed and tested by FEM-analysis (Finite Elements Method) and long-term durability tests.

Improved Hydraulic System

To achieve optimum precision, Hyundai redesigned the hydraulic system to provide the operator with super fine touch and high controllability. Improved pump flow control reduces hydraulic flow when controls are not activated to minimize fuel consumption. Improved hydraulic valves, precise variable volume piston pumps and fine-touch pilot controls make any operator of our 9 series look like a smooth operator.



High Performance on Narrow Jobsites

R80CR-9's reduced tail swing radius allows the operator to work with less worries on narrow jobsites such as road building or urban areas. The Compact radius design provides efficient operation with limited space.



Yanmar 4TNV98

Yanmar 4TNV98 engine provides 24.5 kgf.m (177 lbf.ft) of maximum torque with 60 HP at 2,400 rpm of rated power. This means the R80CR-9 runs with the most power in its class, giving you more power to get the job done.

Profitable

An owner, who knows his machine saves money, takes pleasure in owning it. 9 Series excavators contribute to your business as a time, fuel, spare-part and cost saving earthmoving solution.



*Photo may include optional equipment.

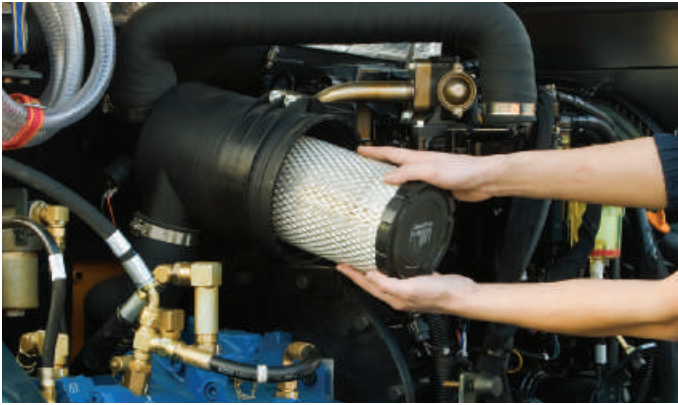

Accessible Air Cleaner

The R80CR-9 is equipped with a durable plastic air cleaner designed for easy maintenance.



Large Engine hood

9 series compact excavator are offering easy access to the engine compartment with a large engine hood.



Improved Durability

The R80CR-9's reinforced arm lug & dozer cylinder cover provide extra protection in tough working conditions.



Centralized Grease Fittings

A centralized lubrication bank is available for faster, easier service and maintenance.



Tilting Cabin

R80CR-9's tiltable cabin provides the operator with convenient maintenance.

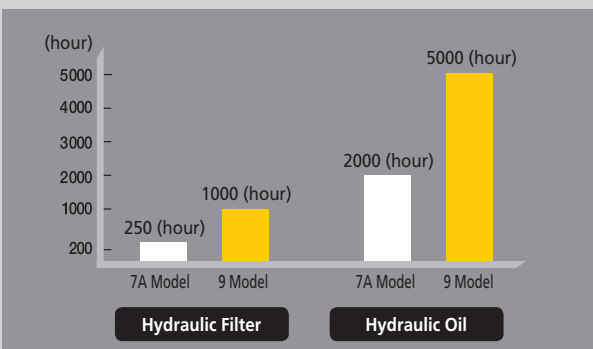

Extended Life of Components

By adopting long-life hydraulic filters (1000 hrs) and long-life hydraulic oil (5000 hrs) operation costs are reduced. Extended lubricant bush life & ultra high molecular weight polymer shim, more efficient cooling systems and integrated preheating systems are extending service intervals and reducing machine down time.

Specifications

ENGINE

MODEL	YANMAR 4TNV98		
Type	Water cooled, 4 cycle Diesel, 4-Cylinders in line, direct injection and low emission		
Rated flywheel horse power	SAE	J1995 (gross)	59.6 HP (44.4 kW) at 2,100 rpm
		J1349 (net)	58.2 HP (43.4 kW) at 2,100 rpm
	DIN	6271/1 (gross)	60.4 PS (44.4 kW) at 2,100 rpm
		6271/1 (net)	59.0 PS (43.4 kW) at 2,100 rpm
Max. torque	24.5 kgf·m (177 lbf·ft) at 1,350 rpm		
Bore x stroke	98 mm (3.86") x 110 mm (4.33")		
Piston displacement	3,319 cc (202 cu in)		
Batteries	1 x 12 V x 100 AH		
Starting motor	12 V - 3.0 kW		
Alternator	12 V - 80 Amp		

HYDRAULIC SYSTEM

MAIN PUMP	
Type	Two variable displacement piston pumps + gear pump
Max. flow	2 x 72 ℓ/min + 53,2 ℓ/min
Sub-pump for pilot circuit	Gear pump
Cross-sensing and fuel saving pump system	
HYDRAULIC MOTORS	
Travel	Two speed axial piston motor with counter balance valve and parking brake
Swing	Axial piston motor with automatic brake

RELIEF VALVE SETTING

Implement circuits	P1 / P2 : 280 kgf/cm ² (3,980 psi) P3 : 230 kgf/cm ² (3,270 psi)
Travel circuit	280 kgf/cm ² (3,980 psi)
Swing circuit	230 kgf/cm ² (3,270 psi)
Pilot circuit	35 kgf/cm ² (500 psi)
Service valve	Installed

HYDRAULIC CYLINDERS

No. of cylinder bore x stroke	Boom: 1-115 x 850 mm (4.5" x 33.5")
	Arm: 1-100 x 873 mm (3.9" x 34.4")
	Bucket: 1-85 x 685 mm (3.3" x 27.0")
	Boom swing: 1-110 x 744 mm (4.3" x 29.3")
	Dozer blade: 1-130 x 152 mm (5.1" x 6.0")

OPERATOR'S CAB

NOISE LEVELS	
Outside cabin - LwA	98 dB
Inside cabin - LpA	78 dB

TRAVEL SYSTEM

Drive method	Full hydrostatic type
Drive motor	Axial piston motor, in-shoe design
Reduction system	Planetary reduction gear
Max. drawbar pull	7,400 kgf (16,310 lbf)
Max. travel speed (high) / (low)	4.3 km/hr (2.7 mph) / 2.8 km/hr (1.7 mph)
Gradeability	35° (70%)
Parking brake	Multi-wet disc

CONTROLS

Pilot pressure operated joysticks and pedals with detachable levers provide almost effortless and fatigueless operation.

Pilot control	Two joysticks with one safety lever (LH): Arm swing, Boom swing (RH): Boom and bucket (ISO)
Traveling and steering	Two levers with pedals
Engine speed	Electric, Dial type

SWING SYSTEM

Swing motor	Axial piston motor
Swing reduction	Planetary gear reduction
Swing bearing lubrication	Grease-bathed
Swing brake	Multi wet disc
Swing speed	9.6 rpm

COOLANT & LUBRICANT CAPACITY

	liter
Fuel tank	120.0
Engine coolant	11.0
Engine oil	11.6
Final drive (each)	1.2
Hydraulic tank	71.0
Hydraulic system	120.0

UNDERCARRIAGE

X-leg type center frame is integrally welded with reinforced box-section track frames. The undercarriage includes lubricate rollers, track adjusters with shock absorbing springs and sprockets, and track chain with triple grouser shoes.

Center frame	X - leg type
Track frame	Pentagonal box type
No. of track shoe on each side	39
No. of carrier rollers on each side	1
No. of track rollers on each side	5

OPERATING WEIGHT

Operating weight, including 3,400 mm (12' 2") boom, 1,670 mm (5' 6") arm, SAE heaped 0.28 m³ (0.37 yd³) digging bucket, lubricant, coolant, full fuel tank, hydraulic tank and the standard equipment.

MAJOR COMPONENT WEIGHT

Upperstructure	4,090 kg (9,020 lb)
Counterweight	930 kg (2,050 lb)
Mono boom (with arm cylinder)	550 kg (1,210 lb)

OPERATING WEIGHT

Operating weight	Steel tracks	8,350 kg (18,410 lb)
	Rubber tracks	8,250 kg (18,190 lb)
Ground Pressure	Steel tracks	0.39 kgf·m / cm ² (5.55 psi)
	Rubber tracks	0.38 kgf·m / cm ² (5.40 psi)

BUCKETS

Capacity		Width		Weight
SAE heaped	CECE heaped	Without side cutters	With side cutters	
0.14 m ³ (0.18 yd ³)	0.13 m ³ (0.17 yd ³)	390 mm (15.4")	470 mm (18.5")	185 kg (410 lb)
0.28 m ³ (0.37 yd ³)	0.25 m ³ (0.33 yd ³)	730 mm (28.7")	810 mm (31.9")	230 kg (510 lb)

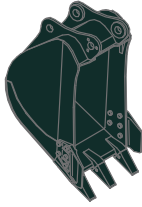

SAE heaped

0.14 m³ (0.18 yd³)

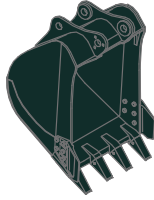

0.28 m³ (0.37 yd³)

DIGGING FORCE (ISO)

Bucket	5,700 kgf
	55.9 kN
	12,570 lbf
Arm	4,300 kgf
	42.2 kN
	9,480 lbf

Lifting Capacities

R80CR-9



Rating over-front



Rating over-side or 360 degrees

Boom : 3.4 m (12' 2") / Arm : 1.67 m (5' 6") / Bucket : 0.28 m³ (0.37 yd³) SAE heaped / Dozer blade down with 930 kg (2,050 lb) counterweight.

Load point height m (ft)	Load radius						At max. reach		Reach m (ft)	
	1.5 m (5 ft)		3.0 m (10 ft)		4.5 m (15 ft)		Capacity			
4.5 m (15 ft)	kg					*1550	1480	*1470	1040	5.74
	lb					*3420	3260	*3240	2290	(17.9)
3.0 m (10 ft)	kg					*1740	1430	*1530	780	6.23
	lb					*3840	3150	*3370	1720	(20.4)
1.5 m (5 ft)	kg		*4050	2510	*2260	1320	*1620	700	700	6.45
	lb		*8930	5530	*4980	2910	*3570	1540	1540	(21.2)
Ground Line	kg		*4830	2320	*2650	1230	*1710	740	740	6.20
	lb		*10650	5110	*5840	2710	*3770	1630	1630	(20.3)
-1.5 m (-5 ft)	kg	*4730	*4730	*4410	2320	*2550	1210	*1760	940	5.38
	lb	*10430	*10430	*9720	5110	*5620	2670	*3880	2070	(17.7)
-3.0 m (-10 ft)	kg		*2810	2430						
	lb		*6190	5360						









- Lifting capacity is based on SAE J1097, ISO 10567.
- Lifting capacity of the Robex Series does not exceed 75% of the tipping load with the machine on firm, level ground or 87% of full hydraulic capacity.
- The load point is a hook located on the back of the bucket.
- (*) indicates the load limited by hydraulic capacity.

Lifting Capacities











R80CR-9

 Rating over-front  Rating over-side or 360 degrees











Boom : 3.4m (12' 2") / Arm : 1.67 m (5' 6") / Bucket : 0.28m³ (0.37yd³) SAE heaped / Dozer blade up with 930 kg (2,050 lb) counterweight.

Load point height m (ft)		Load radius						At max. reach		
		1.5 m (5 ft)		3.0 m (10 ft)		4.5 m (15 ft)		Capacity		Reach m (ft)
										
4.5 m (15 ft)	kg lb					*1550 *3420	1380 3040	1110 2450	970 2140	5.74 (17.9)
3.0 m (10 ft)	kg lb					1540 3400	1340 2950	840 1850	730 1610	6.23 (20.4)
1.5 m (5 ft)	kg lb			2770 6110	2320 5110	1430 3150	1230 2710	760 1680	650 1430	6.45 (21.2)
Ground Line	kg lb			2570 5670	2140 4720	1330 2930	1140 2510	790 1740	680 1500	6.20 (20.3)
-1.5 m (-5 ft)	kg lb	*4730 *10430	*4730 *10430	2570 5670	2140 4720	1310 2890	1120 2470	1010 2230	870 1920	5.38 (17.7)
-3.0 m (-10 ft)	kg lb			2690 5930	2250 4960					

Boom : 3.4m (12' 2") / Arm : 2.20 m (7' 3") / Bucket : 0.28m³ (0.37yd³) SAE heaped / Dozer blade down with 930 kg (2,050 lb) counterweight.

Load point height m (ft)		Load radius						At max. reach				
		1.5 m (5 ft)		3.0 m (10 ft)		4.5 m (15 ft)		6.0 m (20 ft)		Capacity		Reach m (ft)
												
4.5 m (15 ft)	kg lb					*1180 *2600	*1180 *2600			*1280 *2820	810 1790	6.17 (20.2)
3.0 m (10 ft)	kg lb					*1410 *3110	*1410 *3110	*1400 *3090	820 1810	*1320 *2910	630 1390	6.84 (22.4)
1.5 m (5 ft)	kg lb			*3280 *7230	2580 5690	*1970 *4340	1310 2890	*1570 *3460	780 1720	*1390 *3060	570 1260	7.03 (23.1)
Ground Line	kg lb	*1900 *4190	*1900 *4190	*4600 *10140	2270 5000	*2470 *5450	1190 2620	*1730 *3810	730 1610	*1460 *3220	590 1300	6.80 (22.3)
-1.5 m (-5 ft)	kg lb	*3590 *7910	*3590 *7910	*4590 *10120	2220 4890	*2580 *5690	1140 2510			*1500 *3310	720 1590	6.09 (20.0)
-3.0 m (-10 ft)	kg lb	*5800 *12790	*5800 *12790	*3530 *7780	2290 5050	*1890 *4170	1190 2620			*1360 *3000	1220 2690	4.58 (15.0)

Boom : 3.4m (12' 2") / Arm : 2.20 m (7' 3") / Bucket : 0.28m³ (0.37yd³) SAE heaped / Dozer blade up with 930 kg (2,050 lb) counterweight.

Load point height m (ft)		Load radius						At max. reach				
		1.5 m (5 ft)		3.0 m (10 ft)		4.5 m (15 ft)		6.0 m (20 ft)		Capacity		Reach m (ft)
												
4.5 m (15 ft)	kg lb					*1180 *2600	*1180 *2600			870 1920	750 1650	6.17 (20.2)
3.0 m (10 ft)	kg lb					*1410 *3110	1350 2980	880 1940	760 1680	680 1500	580 1280	6.84 (22.4)
1.5 m (5 ft)	kg lb			2850 6280	2390 5270	1420 3130	1220 2690	840 1850	720 1590	610 1340	520 1150	7.03 (23.1)
Ground Line	kg lb	*1900 *4190	*1900 *4190	2520 5560	2090 4610	1290 2840	1100 2430	790 1740	670 1480	640 1410	540 1190	6.80 (22.3)
-1.5 m (-5 ft)	kg lb	*3590 *7910	*3590 *7910	2460 5420	2040 4500	1240 2730	1050 2310			780 1720	660 1460	6.09 (20.0)
-3.0 m (-10 ft)	kg lb	*5800 *12790	*5800 *12790	2540 5600	2110 4650	1290 2840	1100 2430			1320 2910	1130 2490	4.58 (15.0)

- Lifting capacity is based on SAE J1097, ISO 10567.
- Lifting capacity of the Robex Series does not exceed 75% of the tipping load with the machine on firm, level ground or 87% of full hydraulic capacity.
- The load point is a hook located on the back of the bucket.
- (*) indicates the load limited by hydraulic capacity.

Dimensions & Working Ranges

R80CR-9 DIMENSIONS

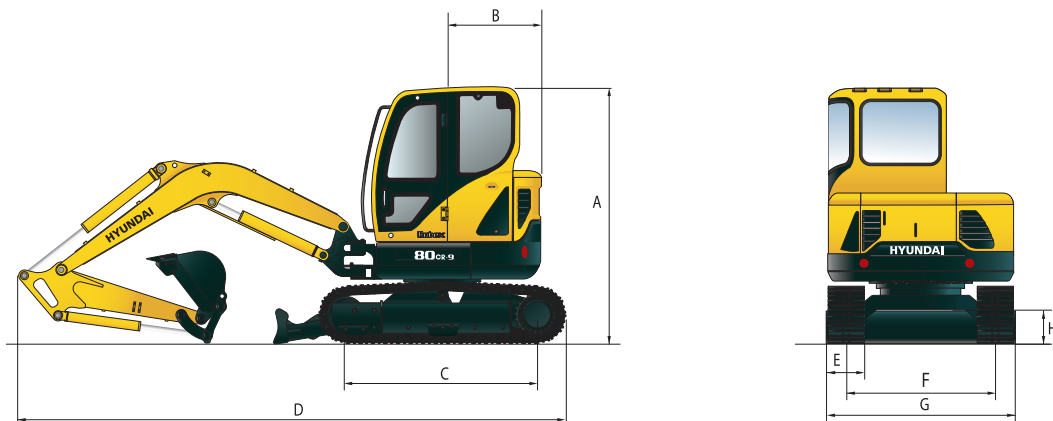

mm (ft · in)

A	Overall height of cab	2,640 (8' 8")	E	Track shoe width	Steel	450 (1' 6")
B	Tail swing radius	1,280 (4' 2")			Rubber	450 (1' 6")
C	Tumbler distance	2,200 (7' 3")	F	Track gauge		1,850 (6' 1")
D	Overall length	6,170 (20' 3")	G	Overall width		2,300 (7' 7")
			H	Ground clearance		360 (1' 2")

R80CR-9 WORKING RANGE

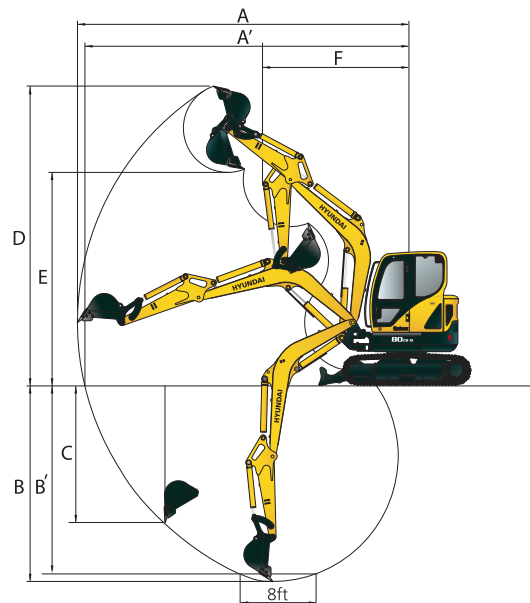

mm (ft · in)

Boom length	3,400 (11' 2")	
Arm length	1,670 (5' 6")	2,200 (7' 3")
A	Max. digging reach	6,960 (22' 10")
A'	Max. digging reach on ground level	6,820 (22' 5")
B	Max. digging depth	4,150 (13' 7")
B'	Max. digging depth (8' level)	3,780 (12' 5")
C	Max. vertical wall digging depth	3,570 (11' 9")
D	Max. digging height	6,740 (22' 1")
E	Max. dumping height	4,730 (15' 6")
F	Min. front swing radius	2,500 (8' 2")

STANDARD EQUIPMENT

ISO standard cabin

- Cabin ROPS (ISO 12117-2)
FOG (ISO 10262 Level 1)
TOPS (ISO 12117)
- All-weather steel cab with all-around visibility
- Safety glass windows
- Rise-up type windshield wiper
- Sliding fold-in front window
- Sliding side window
- Lockable door
- Accessory box & Ash-tray

Centralized monitoring

- Engine speed
- Gauges
 - Fuel level gauge
 - Engine coolant temperature gauge

- Warning lamps
- Fuel level
- Engine oil pressure
- Engine coolant temperature
- Hyd. oil temperature
- Low battery
- Air filter clogging
- Water in Fuel prefilter

Air-conditioner & heater

- Single acting piping kit (breaker, etc)
- Door and cab locks, one key fits all
- Radio / MP3 Player with AUX-input
- Outside rear view mirror
- Fully adjustable suspension seat with seat belt
- Console box tilting system(LH.)
- Three front working lights

Electric horn

- Battery (1 x 12 V x 100 AH)
- Battery master switch
- 12 volt power supply
- Automatic swing brake
- Removable diesel tank
- Water separator, fuel line
- Counterweight
- Mono boom (3.4 m, 11' 2")
- Arm (1.67 m, 5' 6")
- Steel tracks (450 mm, 1' 6")
- Track rail guard
- Starting aid (air grid heater) cold weather

OPTIONAL EQUIPMENT

Fuel filler pump (35 l/min, 9.2 US gpm)

Beacon lamp

Double acting piping kit (clamshell, etc)

Accumulator, work equipment lowering

Travel alarm

Quick coupler

Rubber tracks (450 mm, 1' 6")

Narrow bucket (0.14 m³, 0.18 yd³)

Long arm (2.2 m, 7' 3")

Tool kit

Operator suit

Mechanical suspension seat with heater

Cabin rear work lamp

Pattern change valve (2 patterns)

Steel tracks (600 mm, 1' 12")

* Standard and optional equipment may vary. Contact your Hyundai dealer for more information. The machine may vary according to international standards.

* The photos may include attachments and optional equipment that are not available in your area.

* Materials and specifications are subject to change without advance notice.

* All imperial measurements rounded off to the nearest pound or inch.

PLEASE CONTACT

